

w-NEXT S

7 – 213 kW

Air conditioners for IT Cooling for chilled water feeding.



 EC FAN

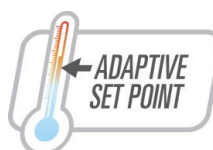

ADAPTIVE
SET POINT



Active
Redundancy

The picture of the unit is indicative and may vary depending on the model

- PERIMETER INSTALLATION
- VARIABLE AIR FLOW AND WATER FLOW
- AIR DELIVERY FROM THE BOTTOM (UNDER) OR FROM THE TOP (OVER)
- PLUG FANS WITH EC ELECTRIC MOTOR
- 2-WAY CHILLED WATER VALVE
- AIR SUCTION TEMPERATURE UP TO 35°C

INDEX

MEHITS CERTIFICATIONS.....	3
GENERAL CHARACTERISTICS	4
INSTALLATION.....	5
PRODUCT FEATURES AND BENEFITS	5
MODEL IDENTIFICATION.....	5
WORKING LIMITS	6
STORING TEMPERATURE.....	6
MAIN COMPONENTS.....	7
OPTIONAL ACCESSORIES	9
TECHNICAL DATA – w-NEXT S OVER / UNDER – EC FANS.....	10
HYDRAULIC DIAGRAM.....	13
2-WAY VALVE FOR WATER FLOW CONTROL.....	13
ACOUSTIC DATA	14
ELECTRICAL DATA.....	14
MICROPROCESSOR CONTROL SYSTEM.....	15
POSSIBLE AIR INTAKE FOR OVER VERSIONS	17
OPTIONAL ACCESSORIES – DOUBLE POWER SUPPLY WITH AUTOMATIC TRANSFER SWITCH	18
OPTIONAL ACCESSORIES – NETWORK ANALYZER.....	19
OPTIONAL ACCESSORIES – FIRE / SMOKE SENSORS	20
OPTIONAL ACCESSORIES - CONDENSATE DISCHARGE PUMP	21
OPTIONAL ACCESSORIES – MODULATING STEAM HUMIDIFIER.....	22
OPTIONAL ACCESSORIES – DEHUMIDIFICATION SYSTEM.....	23
OPTIONAL ACCESSORIES – 2-WAY VALVE FOR BY-PASS.....	24
OPTIONAL ACCESSORIES – ELECTRIC HEATERS	25
OPTIONAL ACCESSORIES – HOT WATER HEATING SYSTEM	26
OPTIONAL ACCESSORIES - FLOOR STAND	28
OPTIONAL ACCESSORIES - DOUBLE PANELS IN EUROCLASS A1	29
OPTIONAL ACCESSORIES – NON-RETURN MOTORIZED DAMPER.....	30
OPTIONAL ACCESSORIES - PLENUM ON AIR DELIVERY/RETURN	32
OPTIONAL ACCESSORIES – DIRECT FREE-COOLING PLENUM	39
OPTIONAL ACCESSORIES – BOTTOM PANEL FOR OVER VERSION.....	42
OPTIONAL ACCESSORIES – COOLNET.....	43
OPTIONAL ACCESSORIES – ADAPTIVE SET-POINT	43
OPTIONAL ACCESSORIES – KIPLINK – KEYBOARD IN YOUR POCKET	43
OPTIONAL ACCESSORIES – RC CLOUD PLATFORM: WEB SERVICES BASED ON CLOUD TECHNOLOGY FOR REMOTE MONITORING AND MANAGEMENT OF AIR CONDITIONING PLANTS.....	44
MACHINE DRAWINGS	45
HOLE IN THE RAISED FLOOR FOR DOWNFLOW VERSION	68
EXAMPLE FOR MACHINES NOISE EMISSION CALCULATION.....	69
VALVE PRESSURE DROP CALCULATION AS FUNCTION OF WATER FLOW RATE.....	71
AIR FILTERS REPLACEMENT.....	72

MEHITS CERTIFICATIONS

SYSTEM CERTIFICATIONS



ISO 9001 CERTIFICATION – MEHITS S.p.A.
Quality Management System



ISO 14001 CERTIFICATION – MEHITS S.p.A.
Environmental Management System



BS OHSAS 18001 CERTIFICATION – MEHITS S.p.A.
Occupational Health and Safety Management System

PRODUCT CERTIFICATIONS BY COUNTRY



CE MARKING
MEHITS units are in compliance with the European Directives in force.



CCC – CQC CERTIFICATION
(People’s Republic of China)



EAC CERTIFICATION
(Russian Federation, Belarus, Kazakhstan)



GENERAL CHARACTERISTICS



w-NEXT S
Downflow air delivery (Under)



w-NEXT S
Upflow air delivery (Over)

w-NEXT S: Air conditioners for IT Cooling with variable air flow, for chilled water feeding.

This series is offered in 14 models, available in the following versions:

- Air intake from the front through honeycomb grille and air delivery from the top of the unit (Over).
- Air intake from the top and air delivery from the bottom of the unit (Under). For unit size E0 air intake from the front through honeycomb grille and air delivery from the bottom.

Cooling capacity: 7 ÷ 213 kW

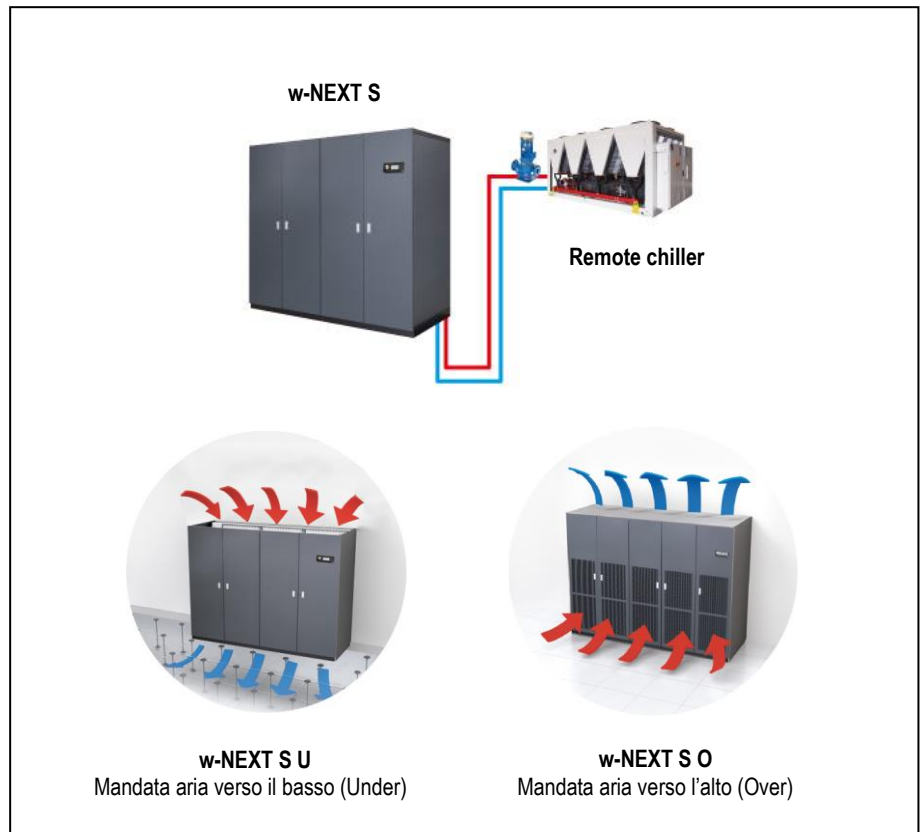

The machines are made for indoor installation.

The constructive solutions and the internal lay-out allow high application flexibility and the frontal access to the main components for the inspection and routine maintenance.

The installation requires electrical and hydraulic connections.

Final assembly on all machines before shipment including running test, reading and monitoring of operating parameters, alarms simulation and visual check.

INSTALLATION

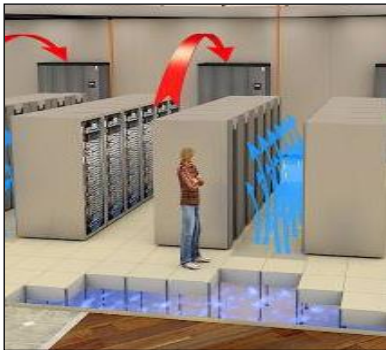

DOWNFLOW VERSION (Under)

Typical installation is on the perimeter.

The units are placed along the perimeter of the data center. Air suction from the top of the unit and air delivery in the underfloor void.

The air distribution is achieved by special tiles placed in front of the racks row, forming cold aisle for air diffusion. On the rear of the racks is expelled the hot air (hot aisle) then aspirated by the unit.

For an optimal installation is advisable to provide the cold aisle containment.

Some solutions provide a service corridor around the server rooms where to place the units. In this case it is necessary to provide the air intake plenum for each unit. With this solution all the space in the Data Center is available for the installation of racks.

UPFLOW VERSION (Over)

The type of installation is practically similar to the previous. The only difference is that for the air distribution in the Data Center is not used the raised floor but ducts in the ceiling.

OPTIONAL

An extensive list of accessories allows the unit to adapt effectively to the real needs of the system, reducing the time and cost of installation.

PRODUCT FEATURES AND BENEFITS

w-NEXT S:

- Wider range and performance increasing
- SHR ratio compared to the previous series, up to 0,95;
- Optimization of the hydraulic circuit;
- New plug fans with EC electric motors with impeller in composite material, which guarantees a reduction of power consumption
- New fans electric motor that do not require maintenance;
- Improvement of the control software, developed by MEHITS, with advanced control logic;
- Increased cooling density, up to 65,2 kW per m²;
- Total front access for the routine maintenance;
- Panels fully removable to facilitate the operations of extraordinary maintenance;

MODEL IDENTIFICATION

Air conditioners for IT Cooling for chilled water feeding

model: w-NEXT S O 072 E5

w-NEXT S	Series
O	Air delivery O = over – upflow air delivery U = under – downflow air delivery
072	Model / Cooling capacity (kW) at nominal conditions
E5	Size

WORKING LIMITS

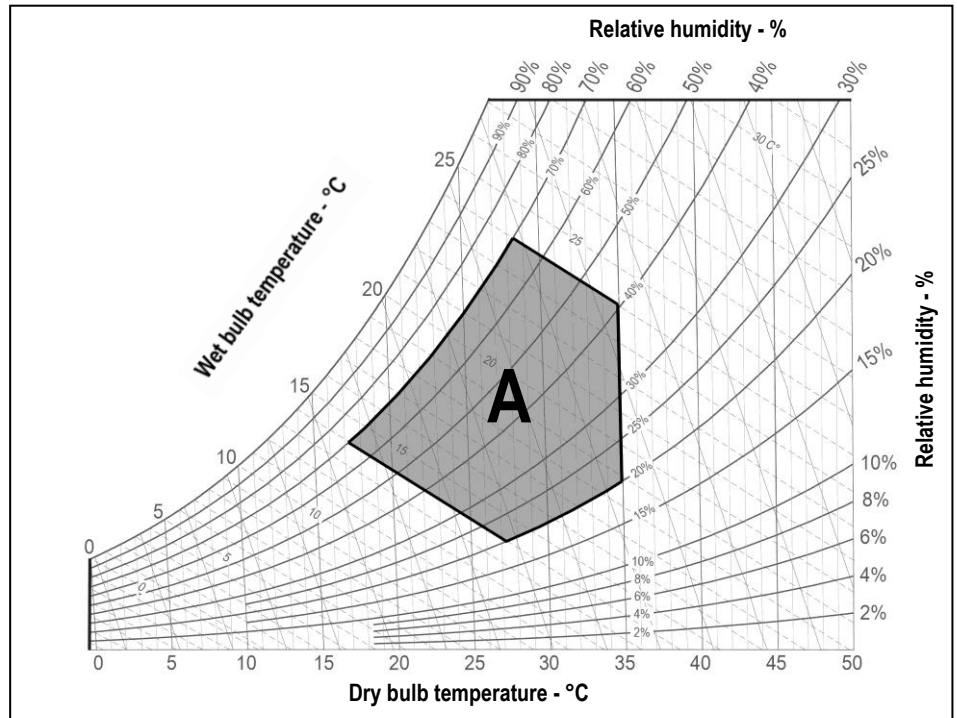

ROOM AIR CONDITIONS

Room air temperature:

- 14°C minimum temperature with wet bulb.
- 24°C maximum temperature with wet bulb.
- 17°C minimum temperature with dry bulb.
- 35°C maximum temperature with dry bulb.

AREA "A". Machine operating envelope.

Room air humidity:

- 20%RH minimum relative humidity.
- 70%RH maximum relative humidity.

CHILLED WATER TEMPERATURE

- 7°C Minimum chilled water inlet temperature
- 12°C Maximum chilled water inlet temperature
- ΔT 4°C Minimum temperature difference between chilled water inlet and outlet
- ΔT 6°C Maximum temperature difference between chilled water inlet and outlet

HYDRAULIC CIRCUIT

- 10 Bar Maximum working pressure of the hydraulic circuit

POWER SUPPLY

- ± 10% Maximum tolerance of the supply voltage (V)

STORING TEMPERATURE

If the machine is not installed on receipt and is stored for a long time, store it in a protected place, at temperatures ranging between -30°C and 50°C in absence of superficial condensation and direct sun light.



MAIN COMPONENTS



FRAMEWORK

- Base in aluminium extrusion, painted with epoxy powders. Colour RAL 9005;
- Frame in aluminium profile, painted with epoxy powders. The inner frame is provided with seals for the panels. Colour RAL 9005;
- Panels in galvanized steel sheet with protective surfaces treatment in compliance with UNI ISO 9227/ASTMB117 and ISO 7253, and painted with epoxy powders. Colour RAL 7016 hammered;
- Panels insulated with polyurethane foam and seals to ensure air tight.
- Hinged front panels with quick release removal system.
- Total front access for routine maintenance.
- Removable lateral and back side panels.
- Air flow OVER version:
 - Air intake from the front through honeycomb type grille and air delivery from the top.
 - Washable air pre-filters with G2 efficiency, with cells in synthetic fibre (size E0 excluded).
- Air flow UNDER version:
 - Machine size E0:
 - Air intake from the front through honeycomb type grille and air delivery from the bottom.
 - Machine size E1, E2, E3, E3P, E4, E5, E6, E7, E8, E9, E10:
 - Air intake from the top and air delivery from the bottom.
- Compartment for electrical panel on unit front for direct access to control and regulation devices;

FILTER SECTION

- Size E0:
 - Washable air filters with G2 efficiency, with cells in synthetic fibre and metallic frame (EN 779-2012).
- Size E1, E2, E3, E3P, E4, E5, E6, E7, E8, E9, E10:
 - Washable air filters with G4 efficiency, with cells in synthetic fibre and metallic frame (EN 779-2012).
- Air filters access:
 - OVER version
 - Frontal access for all machines
 - UNDER version
 - For machines size E0 - E1 - E2 - E3 frontal access
 - For machine size E3P - E4 - E5 - E6 - E7 - E8 - E9 - E10 access from upper side

COOLING SECTION

- Heat exchanger coil with internally corrugated copper tubes and high efficiency aluminium fins, specifically developed to provide high heat transfer and lower pressure drops.
- Finned pack with hydrophilic treatment that assure the condensate water drop, high thermal conductivity and does not favour the growth of micro-organisms.
- 2-way motorized valve for water flow regulation with 0÷10 VDC control actuator and emergency manual control.
- Frame in galvanized steel.
- Condensate tray in peraluman with PVC flexible discharge pipe.
- Air temperature sensors upstream and downstream the cooling section, with control, regulation and limitation functions.
- Temperature probe on chilled water inlet.



FANS SECTION

The fan section is contained within the machine and includes:

- Centrifugal fans with backward curved blades with wing profile, single suction and without scroll housings (Plug-fans), directly coupled to external rotor electric motor.
 - Impeller in composite material exempt from rust formation.
 - Brushless type synchronous EC motor with integrated electronic commutated system and continuous variation of the rotation speed. The motor rotation control is obtained with the EC system (Electronic Commutation) that manage the motor according to the signal coming from the microprocessor control.
- Fans control with proportional signal 0-10V.
- Fan guard with rubber support (UNDER version)



ELECTRICAL PANEL

In accordance with EN60204-1 norms, suitable for indoor installation, complete with:

- Main switch with door lock safety on frontal panel;
- Magneto-thermic switches for supply fans.
The supply fans equipped with EC electric motor and don't require contactors.
- Transformer for auxiliary circuit and microprocessor supply.
- Terminals:
OUTLETS
 - Voltage free deviating contact for General Alarm 1-2.
 - Voltage free contact for supply fans status.INLETS
 - External enabling.
- Power supply 230/1/50 for size E0; 400/3/50+N for size from E1 to E10, both included.



CONTROL SYSTEM

Microprocessor control system with graphic display for control and monitor of operating and alarms status.

The system includes:

- Built-in clock for alarms date and time displaying and storing;
- Built-in memory for the storing of the intervened events (up to 200 events recorded);
- Predisposition for additional connectivity board housing (MBUS RS485/JBUS, MBUS RS232/JBUS for GSM modem, LON, BACnet for Ethernet (SNMP- TCP/IP), BACnet for MS/TP). The electronic cards are optional accessories.
- Main components hour-meter;
- Non-volatile "Flash" memory for data storage in case of power supply faulty;
- Menu with protection password;
- LAN connection (max 10 units).

OPTIONAL ACCESSORIES

The descriptions of these additional components can be found in Chapter OPTIONAL ACCESSORIES.

- Double power supply with automatic change-over. Not compatible with “oversized electric heaters” and “oversized humidifier” optional accessories.
- Network analyzer: multifunction utility for calculating and displaying the machine electrical measurements.
- Smoke sensor. Supplied in mounting kit.
- Fire sensor. Supplied in mounting kit.
- Condensate drain system. Supplied in mounting kit. The system includes pump with activation float and 10 linear meters long discharge pipe.
- Modulating steam humidifier with immersed electrodes with electronic control. The optional foresee the combined Temperature / Humidity sensor on return air.
- Dehumidification system. The optional foresee the combined Temperature / Humidity sensor on return air.
- Electric heating system consisting of aluminium armoured elements with integral fins
- Hot water heating system.
- 2-way motorized valve with 0÷10 VDC control actuator and emergency manual control for the third way (by-pass) of the hydraulic circuit. The valve is in combination with the main water flow control valve.
- Unit floor stand with height adjusting rubber holders. It is not possible to match the unit floor stand with plenum installed under the machine.
- Double panels in Euroclass A1.
- Washable air filter with M5 efficiency (size E0 excluded). Not compatible with optional plenum with M6/F7/F9 efficiency filters on air delivery.
- Non-return air damper driven by electric servomotor installed on the machine air delivery (size E0 excluded).
- Empty plenum. Available in Euroclass A1.
- Plenum with noise absorption partitions on air delivery (size E0 excluded).
- Plenum with M6/F7/F9 efficiency filters on air delivery (size E0 excluded). Not compatible with washable air filter with M5 efficiency.
- Air distribution plenum with double row adjustable grille on front side. Available in Euroclass A1.
- Air distribution plenum with double row adjustable grilles on three sides. Available in Euroclass A1.
- Air distribution plenum with double row adjustable grille on front side and noise absorption partitions (size E0 excluded).
- Plenum for direct free-cooling on air intake (size E0 excluded) . The optional foresee the combined Temperature / Humidity sensor on machine air suction and the Temperature sensor for ambient air.
- Unit base noise insulation with special bottom panel for OVER version (size E0 excluded).
Restriction: Not compatible with blind frontal panel for OVER version.
- COOLNET: application software to maximize energy saving in Load Sharing.
- ADAPTIVE SET POINT: software that optimizes the operation of liquid chillers connected to the indoor air conditioners by control of the effective room thermal load.
- KIP LINK: Keyboard in your pocket. Allows to operate on the unit with smartphone or tablet.
- RC CLOUD PLATFORM: Web services based on cloud technology for remote monitoring and management.

OTHER ACCESSORIES

- Automatic system for the air pressure control in the under floor. The system controls the supply fans rotation speed in order to keep constant the air pressure in the under floor via a differential pressure transmitter connected to the microprocessor control.
- Blind frontal panel for OVER version (size E0 excluded). The accessory allows the intake air from the bottom of the machine.
Restriction: Not compatible with unit base noise insulation with special bottom panel for OVER version.
- Differential pressure switch on the air side for clogged filters alarm signal.
- Under floor water alarm through sensor to be placed on the floor.
- Additional underfloor water sensor kit.
- Combined Temperature / Humidity sensor on return air.
- Temperature sensor for outdoor installation.
- Combined Temperature / Humidity sensor for remote installation. The optional is added to the standard sensor on machine air suction.
- Microprocessor control accessories:
 - Remote terminal.
 - Serial card MBUS RS485/JBUS.
 - Serial card MBUS RS232/JBUS for GSM modem.
 - Serial card LON.
 - Serial card BACnet for Ethernet – SNMP – TCP/IP.
 - Serial card BACnet for MS/TP.
 - Temporary microprocessor power supply. The system guarantees the microprocessor power supply for a few minutes, in case of supply voltage failure.
 - Smoke or Fire sensor contact.
 - Analogue set point compensation according to an external analogue signal at Customer care.
The microprocessor control, through the additional module “expansion card”, can manage a compensation signal of the return air setpoint by analogue input (0...1V; 0...5V; 0,5...4,5V; 4...20mA; 0...20mA). The compensation curve allows to assign a temperature setpoint offset respectively to the minimum and maximum signal managed by the input.

WARNING

MEHITS reserves the right to accept the matching of the optional installed on the machine.

TECHNICAL DATA – w-NEXT S Over / Under – EC Fans

MODEL		007	013	021	032	045	053
SIZE		E0	E1	E2	E3	E3P	E4
COOLING CAPACITY (1)							
Total	kW	6,7	13,3	21,4	31,8	45,8	52,8
Sensible	kW	5,8	11,7	19,4	29,9	42,1	49,8
SHR (2)	kW/kW	0,87	0,88	0,91	0,94	0,92	0,94
"EC" SUPPLY FANS							
Air flow	m ³ /h	1800	2900	4920	7800	10800	13100
Nominal external static pressure	Pa	20	20	20	20	20	20
Maximum external static pressure	Pa	85	38	75	760	200	95
Fans power input (3)	kW	0,12	0,34	0,79	1,53	1,81	2,15
COOLING COIL							
Water flow rate (1)	m ³ /h	1,2	2,3	3,7	5,5	7,9	9,1
dP coil + valve (1)	kPa	43	29	78	65	58	55
Water volume	l	2,2	4,2	5,3	7,8	11,4	13,8
AIR FILTERS							
Filter area	m ²	0,28	0,61	0,78	1,24	1,71	2,07
Efficiency		G2	G4	G4	G4	G4	G4
POWER SUPPLY							
	V/Ph/Hz	230/1/50	400/3/50+N	400/3/50+N	400/3/50+N	400/3/50+N	400/3/50+N
ENERGY EFFICIENCY INDEX (1)							
EER Energy Efficiency Ratio	kW/kW	55,8	39,1	27,1	20,8	25,3	24,6
DIMENSIONS							
Length	mm	655	650	785	1085	1085	1305
Width	mm	445	675	675	775	930	930
Height	mm	1680	1925	1925	1925	1925	1980
NET WEIGHT OVER							
	kg	150	203	239	302	321	345
NET WEIGHT UNDER							
	kg	150	216	257	325	329	379
HYDRAULIC CONNECTIONS							
WATER INLET / OUTLET ISO 7/1 - R	Ø	3/4"	1"	1"	1+1/4"	1+1/4"	1+1/2"
CONDENSATE DISCHARGE							
Rubber pipe – internal diameter	Ø mm	19	19	19	19	19	19

THE COOLING CAPACITY DOES NOT CONSIDER THE SUPPLY FAN MOTOR THERMAL LOAD

1. Gross value. Characteristics referred to entering air at 24°C-50%RH with chilled water temperature 7-12°C - 0% glycol. ESP=20Pa.
2. SHR = Sensible cooling capacity / Total cooling capacity.
3. Corresponding to the nominal external static pressure.

TECHNICAL DATA – w-NEXT S Over / Under – EC Fans

MODEL		072	081	100	120	138
SIZE		E5	E6	E7	E8	E9
COOLING CAPACITY (1)						
Total	kW	72,5	80,7	100,0	121,0	140,0
Sensible	kW	64,6	76,1	94,0	111,0	128,0
SHR (2)	kW/kW	0,89	0,94	0,94	0,92	0,91
"EC" SUPPLY FANS						
Air flow	m ³ /h	16350	20000	24200	28300	33100
Nominal external static pressure	Pa	20	20	20	20	20
Maximum external static pressure	Pa	405	350	155	150	475
Fans power input (3)	kW	2,57	3,14	3,98	5,66	6,09
COOLING COIL						
Water flow rate (1)	m ³ /h	12,5	13,9	17,2	20,9	24,1
dP coil + valve (1)	kPa	75	52	54	85	76
Water volume	l	18,1	21,2	24,6	28,5	33,8
AIR FILTERS						
Filter area	m ²	2,59	3,16	3,83	4,47	5,24
Efficiency		G4	G4	G4	G4	G4
POWER SUPPLY						
	V/Ph/Hz	400/3/50+N	400/3/50+N	400/3/50+N	400/3/50+N	400/3/50+N
ENERGY EFFICIENCY INDEX (1)						
EER Energy Efficiency Ratio	kW/kW	28,2	25,7	25,1	21,4	23,0
DIMENSIONS						
Length	mm	1630	1875	2175	2499	2899
Width	mm	930	930	930	930	930
Height	mm	1980	1980	1980	1980	1980
NET WEIGHT OVER						
	kg	428	483	535	598	679
NET WEIGHT UNDER						
	kg	470	531	589	660	753
HYDRAULIC CONNECTIONS						
WATER INLET / OUTLET ISO 7/1 - R	Ø	2"	2"	2+1/2"	2+1/2"	3"
CONDENSATE DISCHARGE						
Rubber pipe – internal diameter	Ø mm	19	19	19	19	19

THE COOLING CAPACITY DOES NOT CONSIDER THE SUPPLY FAN MOTOR THERMAL LOAD

1. Gross value. Characteristics referred to entering air at 24°C-50%RH with chilled water temperature 7-12°C - 0% glycol. ESP=20Pa.
2. SHR = Sensible cooling capacity / Total cooling capacity.
3. Corresponding to the nominal external static pressure.

TECHNICAL DATA – w-NEXT S Under – EC Fans

MODEL		160 (*)	215 (*)
SIZE		E10	E10
COOLING CAPACITY (1)			
Total	kW	163,0	213,0
Sensible	kW	144,0	169,0
SHR (2)	kW/kW	0,88	0,79
"EC" SUPPLY FANS			
Air flow	m ³ /h	37150	37150
Nominal external static pressure	Pa	20	20
Maximum external static pressure	Pa	110	110
Fans power input (3)	kW	6,44	6,44
COOLING COIL			
Water flow rate (1)	m ³ /h	28,1	36,6
dP coil + valve (1)	kPa	111	118
Water volume	l	44,0	66,0
AIR FILTERS			
Filter area	m ²	6,54	6,54
Efficiency		G4	G4
POWER SUPPLY	V/Ph/Hz	400/3/50+N	400/3/50+N
ENERGY EFFICIENCY INDEX (1)			
EER Energy Efficiency Ratio	kW/kW	25,3	33,1
DIMENSIONS			
Length	mm	3510	3510
Width	mm	930	930
Height	mm	1980	1980
NET WEIGHT OVER	kg	-	-
NET WEIGHT UNDER	kg	900	970
HYDRAULIC CONNECTIONS			
WATER INLET / OUTLET ISO 7/1 - R	Ø	3"	3"
CONDENSATE DISCHARGE			
Rubber pipe – internal diameter	Ø mm	19	19

THE COOLING CAPACITY DOES NOT CONSIDER THE SUPPLY FAN MOTOR THERMAL LOAD

1. Gross value. Characteristics referred to entering air at 24°C-50%RH with chilled water temperature 7-12°C - 0% glycol. ESP=20Pa.
 2. SHR = Sensible cooling capacity / Total cooling capacity.
 3. Corresponding to the nominal external static pressure.
- (*) Only UNDER version

HYDRAULIC DIAGRAM

Below hydraulic diagram referred to the standard configuration without optional.

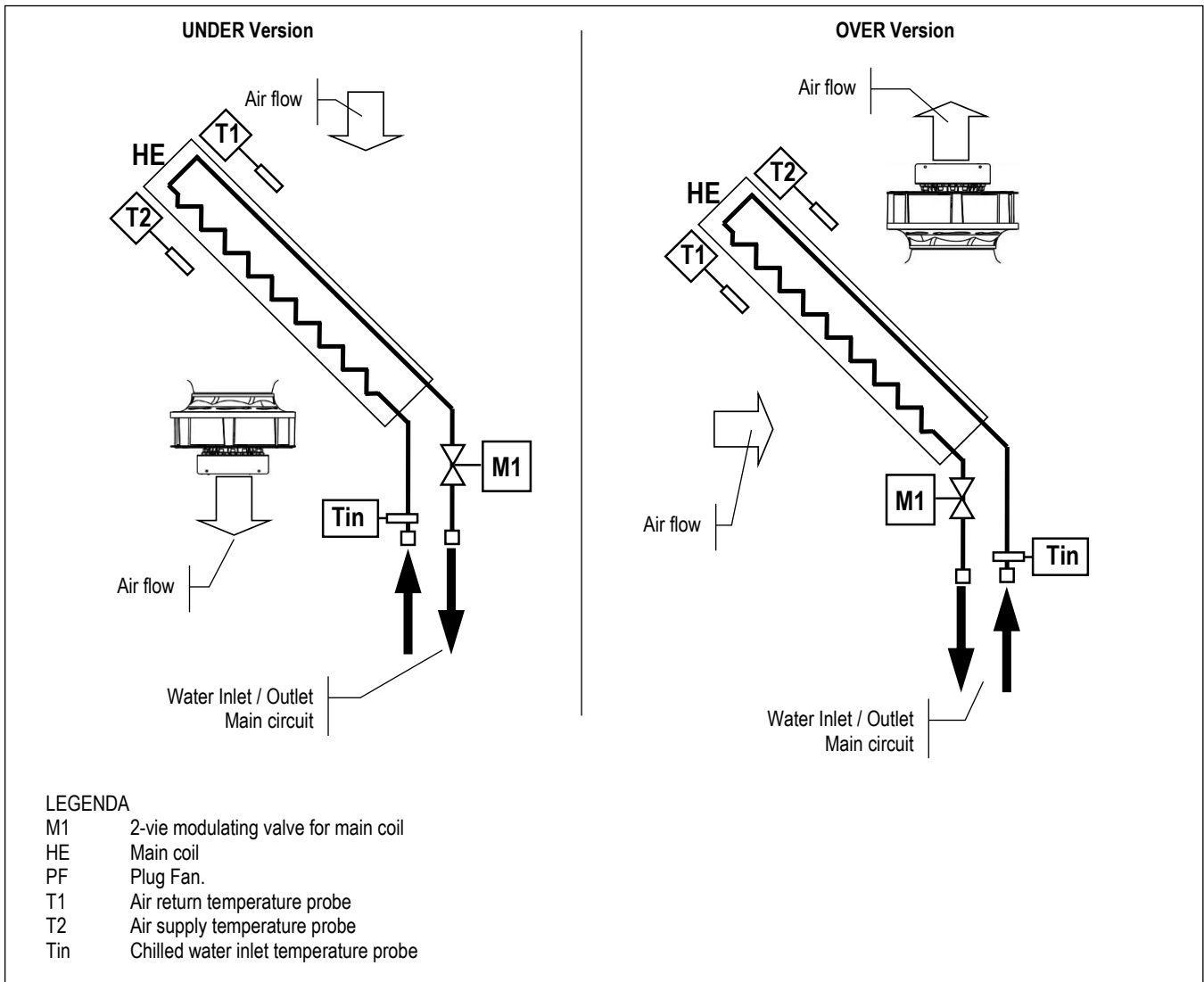

2-WAY VALVE FOR WATER FLOW CONTROL



The water flow control in the finned coil is achieved through a **2-way modulating ball valve with equal percentage flow control** ensured by the integrated characterizing disc.

This type of valve offers the following series of benefits:

- Equal percentage flow control.
- Closing seal with leakage rate in Class A (EN 12266-1)
- No peaks initial flow.
- Excellent stability control thanks to the integrated characterizing disc.
- Closing pressure very high.
- Excellent characteristic in partialisation.
- Stability in control.
- Wide operating pressures which provide an optimal adjustment of the water flow even under extreme conditions.
- Maintenance free.
- Self-cleaning.

The rotative actuator is controlled by a signal 0 ... 10VDC from the microprocessor controller. The actuator is equipped with an emergency button for manual operation and is maintenance-free.



ACOUSTIC DATA

Acoustic data of the standard machine at full load working conditions.

WARNING:

In a closed room the noise produced by a sound source reaches the listener in two different ways:

- Directly
- Reflected from the surrounding walls, floor, ceiling, from furniture.

With the same sound source, the noise produced in a closed room is greater than that produced outdoors. In fact, the sound pressure level generated by the source, must be added to the one reflected from the room. Also, the shape of the room affects the sound.

w-NEXT S Over / Under

MODEL		007	013	021	032	045	053	072	081	100	120	138	160	215
SIZE		E0	E1	E2	E3	E3P	E4	E5	E6	E7	E8	E9	E10	E10
SOUND LEVEL (1)														
On air delivery Under	dB(A)	62,9	65,5	75,2	76,0	78,8	79,1	79,7	80,2	80,7	84,5	84,1	83,0	83,0
On air intake Under	dB(A)	50,1	56,0	60,9	61,9	66,2	66,5	65,5	67,5	68,0	70,4	71,5	70,3	70,3
On front side Under	dB(A)	43,4	46,8	51,4	52,3	56,7	57,1	55,9	58,1	58,6	60,8	62,0	60,9	60,9
On air delivery Over	dB(A)	62,9	65,5	75,2	76,0	78,8	79,1	79,7	80,2	80,7	84,5	80,7	-	-
On air intake Over (2)	dB(A)	50,1	50,9	55,3	56,4	60,7	61,1	60,0	62,1	62,6	64,9	62,6	-	-
On front side Over (3)	dB(A)	43,4	46,8	51,4	52,3	56,7	57,1	55,9	58,1	58,6	60,8	58,6	-	-

1. Noise pressure level at 1 meter in free field – ISO 3744
2. Air intake from the front
3. Air intake from the bottom

ELECTRICAL DATA

w-NEXT S Over / Under

MODEL		007	013	021	032	045	053	072
SIZE		E0	E1	E2	E3	E3P	E4	E5
Power supply		230/1/50	400/3/50+N	400/3/50+N	400/3/50+N	400/3/50+N	400/3/50+N	400/3/50+N
Maximum current input (FLA)	A	1,2	0,3	1,7	4,2	4,4	4,2	8,4

MODEL		081	100	120	138	160(*)	215(*)
SIZE		E6	E7	E8	E9	E10	E10
Power supply		400/3/50+N	400/3/50+N	400/3/50+N	400/3/50+N	400/3/50+N	400/3/50+N
Maximum current input (FLA)	A	8,9	8,3	12,6	13,3	12,5	12,5





(*) Only UNDER version

MICROPROCESSOR CONTROL SYSTEM

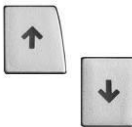

The microprocessor control system is equipped with 6 keys terminal and back lighted graphic display on which all information in different languages or easily identifiable symbols are displayed. The system disposes of a “flash” memory that preserves the information even in absence of power supply. Part of memory is dedicated to the registration of intervened events - up to 200 events.

KEYBOARD FUNCTIONS

	ALARM	Alarm, Back-red light active – alarm presence, push to have alarm description. If more than one alarm(s), the others can be scrolled by Key UP / DOWN
	PRG	Menu list, scrolled by key UP/DOWN: Unit; Set-point; In/Out; Clock; History; User; Service; Factory. Use the ENTER key to execute the mode.
	ESC	Home. Used to come back to the previous menu level or to the main screen.
	UP DOWN	Used to change the pages and values of sets. When display is in main screen (HOME), pressing one of them (UP/DOWN) will display the synoptic of the main controls.
	ENTER	Moving the cursor on adjustable Program(s) fields, to confirm the changes, press the key (ENTER) to get out of the fields.

CONNECTIVITY

Through the optional serial port, the microprocessor control enables communication with the modern buildings BMS systems with the following protocols:

- MBUS/JBUS (RS485) serial card;
- MBUS/JBUS (RS232) for GSM modem serial card;
- LON Works serial card;
- BACnet per Ethernet – SNMP – TCP/IP serial card;
- BACnet per MS/TP serial card;

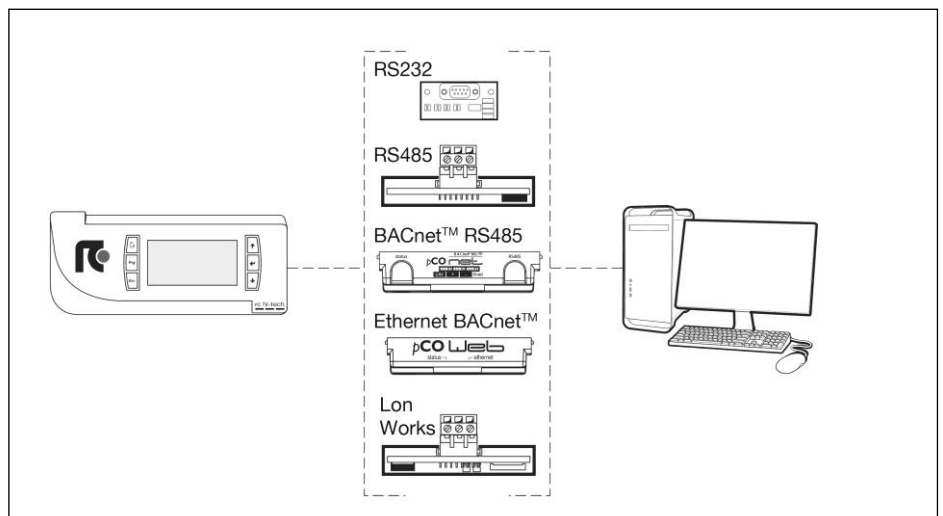

PASSWORD

- Level 1: On request of the End User. Allowing to reach USER menu
- Level 2: Asks to MEHITS Service: Allowing to reach SERVICE menu
- Level 3: Asks to MEHITS Service: Allowing to reach FACTORY menu

No passwords request to enter: UNIT, SETPOINT, IN/OUT, CLOCK, HISTORY menu

LAN NETWORK

The LAN is part of the control software and it is possible to connect up to 10 units.
 This type of connection allows to control the units in coherent way, moreover the units can be controlled and managed from a shared remote terminal.
 Electrical connections are on electrical panel connecting terminals.

LAN ADDRESS LIST

Unit #	1	2	3	4	5	6	7	8	9	10	Remote Terminal
Terminal address	1	2	3	4	5	6	7	8	9	10	32
Mother board address	11	12	13	14	15	16	17	18	19	20	-

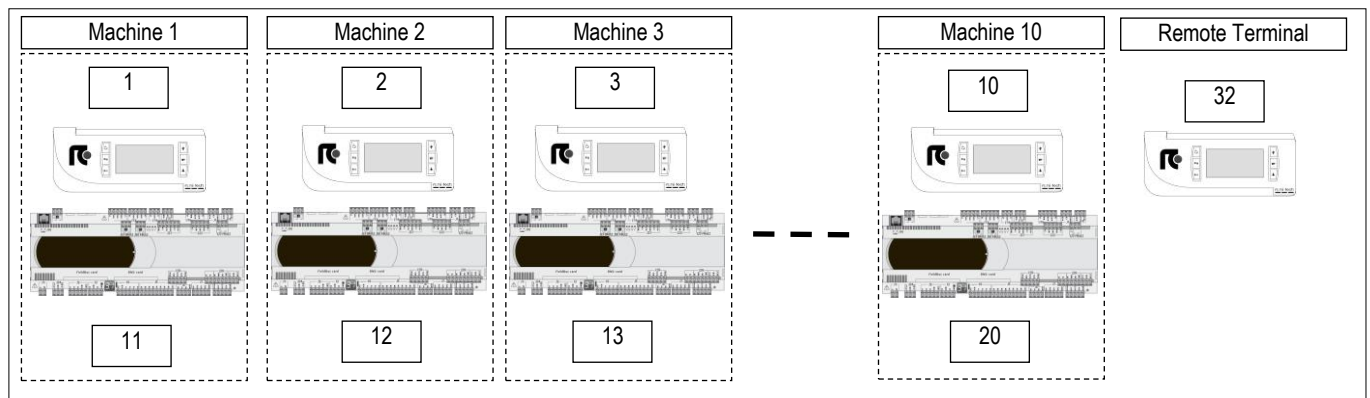

The unit connection to the local network (LAN) allows to perform the following functions:

- Balancing the operating hours among the different units by rotating the reserve units (Stand-by)
- Turning on the reserve units in case other units should turn off due to an alarm, maintenance or power feed interruption
- Turning on reserve units to offset the excessive thermal load
- Checking up to 10 units with a single user terminal (shared user terminal)

POSSIBLE AIR INTAKE FOR OVER VERSIONS

OVER VERSION - AIR INTAKE FROM THE BOTTOM

Thanks to the particular basement design, it is possible to have the unit air intake from the bottom side. With this solution, it is necessary to foresee the optional blind frontal panels

OVER VERSION - AIR INTAKE FROM THE BACK SIDE

(Sizes E3P, E4, E5, E6, E7, E8, E9, E10 excluded)

It is possible to have the unit air intake from the back side.

Due to the limited size of the air intake, the air flow is limited to the 20% of the nominal one.

The air intake has to be made by Customer during installation.

In case the air intake is used for fresh air, it is necessary the temperature / humidity probe reposition in front of the heat exchanger, to allow for optimum reading of the values of temperature / humidity.

The electric cable of the probe has sufficient length for the repositioning.

AIR INTAKE FROM THE BACK SIDE

Back side view

w-NEXT S OVER
E1 – E2 – E3

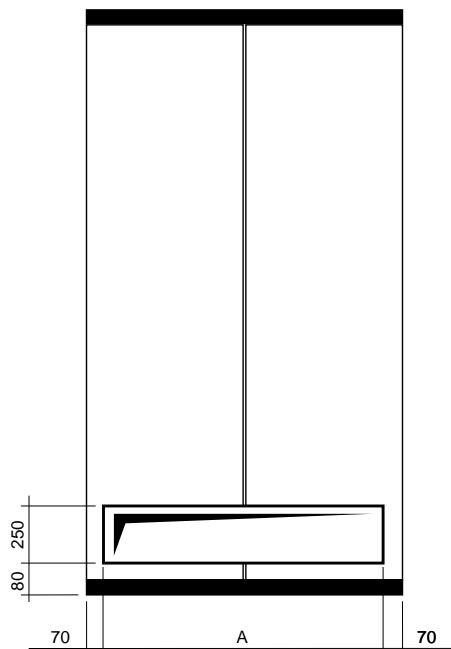

w-NEXT S OVER		E1	E2	E3
A	mm	510	645	945
Max air flow	m ³ /h	600	1000	1500

OPTIONAL ACCESSORIES – DOUBLE POWER SUPPLY WITH AUTOMATIC TRANSFER SWITCH



The optional is not available for size E0.

The optional is not compatible with “oversized electric heaters” and “oversized humidifier” optional accessories.

The motorised changeover switches automatically manage changeover under load between two three-phase power supplies, or manually for emergency operations.

These transfer switching (TSE) devices are suitable for low voltage systems with interruption of the supply to the load during transfer.

The model supplied in the automatic version checks the source and switches over automatically, based on configurable parameters.

OPEN TRANSITION TYPE TRANSFER SWITCH WITH A MINIMUM INTERRUPTION OF THE SUPPLY DURING TRANSFER.

To maintain the microprocessor powered and avoid its restarts is mandatory to foresee the installation of the “temporary microprocessor power supply” optional accessory. The system guarantees the microprocessor power supply for a few minutes, in case of supply voltage failure.

The remote condenser must be powered by the automatic transfer switch. The installation of “Electrical power supply for remote condenser from the indoor machine electrical board” optional accessory is requested.

ATS INSTALLATION

Frame	Power Supply	ATS Installation
E1	400/3/50+N	EXTERNAL, supplied in kit
E2	400/3/50+N	EXTERNAL, supplied in kit
E3	400/3/50+N	EXTERNAL, supplied in kit
E4	400/3/50+N	EXTERNAL, supplied in kit
E5	400/3/50+N	INTERNAL (on unit electrical panel)
E6	400/3/50+N	INTERNAL (on unit electrical panel)
E7	400/3/50+N	INTERNAL (on unit electrical panel)
E8	400/3/50+N	INTERNAL (on unit electrical panel)
E9	400/3/50+N	INTERNAL (on unit electrical panel)

For EXTERNAL installation, ATS is supplied in special box with IP 3X ingress protection, with the dimensions shown in the figure below.

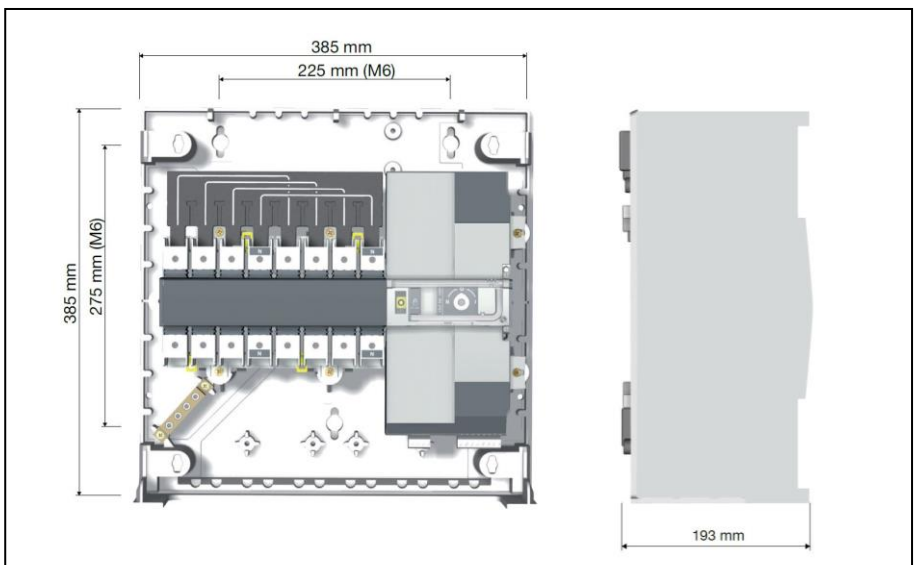

OPTIONAL ACCESSORIES – NETWORK ANALYZER



The optional is not available for size E0.

The optional is installed within the electrical box downstream the main switch with door safety lock:

- Network transducer;
- Current transformers, one for each power supply phase cable.

This device provides continuous measurement of power consumption, monitoring current, voltage and power. These values are sent to unit microprocessor via RS485 serial cable, as shown on the unit wiring diagram.

The displayed variables are:

- Phase to phase voltage, only for three-phase units;
- Phase voltage (phase-neutral);
- Phase current;
- Neutral current only for three-phase units;
- Active phase power, only for three-phase units;
- Total active power;
- Active energy;
- Hour counts

OPTIONAL ACCESSORIES – FIRE / SMOKE SENSORS

Is possible to install one or both of the following sensors. Sensors are supplied in mounting kit. Installation within the room at customer care.



SMOKE DETECTOR

The optical smoke detector senses the presence of combustion by-products (visible smoke) and activates an alarm.

The operating principle is based on the light scattering technique (Tyndall effect).

The device is in conformity to EN 54-7 standard.

Technical features:

Material	ABS
Power supply	12...28 Vdc
Normal current	50µA a 24 Vdc
Alarm current	25mA a 24 Vdc
LED visibility	360° (double led)
Storage temperature	-10...+70°C
Operating temperature	-10...+70°C
Max. speed air	0,2 m/s
Relative humidity	<93% not-condensing
Index of protection	IP 20
Testing by magnet	Yes
Relay	max. 1A 30Vdc
Signal repeater	14mA a 24 Vdc
Sensor coverage:	40m ² max
Shielded connection cable	sez. min 0,5 mm ²
Colour	White

WARNING:

For correct detector operation, periodical maintenance must be performed.



HEAT DETECTOR

The heat detector has been designed to identify temperatures at which fires may start. When the temperature exceeds the set threshold or when there is a rapid variation in temperature, the relay is activated to signal an alarm.

The device is in conformity to EN 54-5 standard.

Technical features:

Material	ABS
Power supply	12...28 Vdc
Normal current	50µA a 24 Vdc
Alarm current	25mA a 24 Vdc
LED visibility	360° (double LED)
Storage temperature	-10...+70°C
Operating temperature	-10...+70°C
Relative humidity	<93% non-condensing
Index of protection	IP 20
Testing by magnet	Yes
Relay	max. 1A 30Vdc
Signal repeater	14mA a 24 Vdc
Alarm temperature threshold	62°C
Sensor coverage:	40m ² max
Shielded connection cable	min 0.5 mm ²
Colour	White

WARNING:

For correct detector operation, periodical maintenance must be performed.



OPTIONAL ACCESSORIES - CONDENSATE DISCHARGE PUMP



A plastic case contains the vertical type pump, the water tank with float plus safety switch and hydraulic and electric connection.

Together the pump 10 linear meters anti-crushing plastic discharge spiral tube is supplied. The optional must be installed as shown in the documentation delivered together with the unit.

Wiring includes power supply and an alarm, displayed on microprocessor, that includes motor pump thermal protection and tank overflow.

The condensate discharge pump operation is fully automatic.

WARNING

For all the machines the optional accessory is supplied in mounting kit.

TECHNICAL DATA

- Power supply: 230V~ 50Hz
- Electrical data: 70W – 0,67A
- Maximum water flow: 500 l/h
- Maximum delivery height: 5.0 m
- Sound level: 45dBA a 1 m
- Maximum water temperature: 70°C
- Water acidity: pH>2.5
- Tray volume: 2.0 l
- Protection IP 20

CONDENSATE DISCHARGE PUMP

(Dimensions in millimetres)

OPERATING DATA

Discharge head	Total lenght of discharge pipes (Ø 10 mm internal)			
	5m	10m	20m	30m
1m	380	300	240	190
2m	310	260	200	150
3m	240	200	145	110
4m	150	130	80	60
5m	30	20	0	0

OPTIONAL ACCESSORIES – MODULATING STEAM HUMIDIFIER



Modulating steam humidifier with immersed electrodes fitted with safety and running accessories.

The optional includes the combined temperature / humidity sensor on unit air intake.

The accessory is factory installed and requires water filling connection.

Humidifier water charge and discharge pipes are not supplied.

It is recommended to install a filter and a shut-off valve on the pipe to the water inlet.

This humidifier produces non-pressurized steam by electrodes immersed in the water inside the cylinder: they bring the electric phase in the water that works as an electrical resistance and overheats. The steam so produced is distributed with dedicated distributors and used for ambient humidification or for industrial processes.

CHARACTERISTICS OF THE SUPPLY WATER

The quality of the used water influences the evaporation process, so the humidifier can be fed with **not-treated water, only when potable and non-demineralised.**

LIMIT VALUES

		Min	Max
Hydrogen ions	pH	7	8,5
Specific conductivity at 20°C	$\sigma_{R, 20^\circ C}$ $\mu S/cm$	300	1250
Total dissolved solids	TDS mg/l	(1)	(1)
Dry residue at 180°C	R ₁₈₀ mg/l	(1)	(1)
Total hardness	TH mg/l CaCO ₃	100 (2)	400
Temporary hardness	mg/l CaCO ₃	60 (3)	300
Iron + Manganese	mg/l Fe + Mn	0	0,2
Chlorides	ppm Cl	0	30
Silica	mg/l SiO ₂	0	20
Residual chlorine	mg/l Cl ⁻	0	0,2
Calcium sulphate	mg/l CaSO ₄	0	100
Metallic impurities	mg/l	0	0
Solvents, diluents, soaps, lubricants	mg/l	0	0

(1) Values depending on specific conductivity;

in general: TDS $\cong 0,93 * \sigma_{R, 20^\circ C}$; R₁₈₀ $\cong 0,65 * \sigma_{R}$

(2) Not lower than 200% of the chloride content in mg/l di Cl⁻

(3) Not lower than 300% of the chloride content in mg/l di Cl⁻

WARNING:

- No relation can be demonstrated between water hardness and conductivity.
- **Do not treat water with softeners!** This could cause corrosion of the electrodes or the formation of foam, leading to potential operating problems or failures.
- Do not add disinfectants or corrosion inhibitors to water, as these substances are potentially irritant.
- Is absolutely forbidden to use well water, industrial water or water drawn from cooling circuits; in general, avoid using potentially contaminated water, either from a chemical or bacteriological point of view

TECHNICAL DATA HUMIDIFIER – w-NEXT S Over / Under

MODEL		007	013	021	032	045	053	072	081	100	120	138	160(*)	215(*)
SIZE		E0	E1	E2	E3	E3P	E4	E5	E6	E7	E8	E9	E10	E10
VAPOUR PRODUCTION	kg/h	2,0	3,0	3,0	3,0	3,0	8,0	8,0	8,0	15,0	15,0	15,0	15,0	15,0
Power input	kW	1,4	2,3	2,3	2,3	2,3	6,0	6,0	6,0	11,3	11,3	11,3	11,3	11,3
Absorbed current (OA)	A	6,1	3,2	3,2	3,2	3,2	8,7	8,7	8,7	16,2	16,2	16,2	16,2	16,2
Max absorbed current (FLA)	A	8,8	4,5	4,5	4,5	4,5	12,4	12,4	12,4	23,0	23,0	23,0	23,0	23,0
Water content	l	3,9	3,9	3,9	3,9	3,9	6,4	6,4	6,4	10,3	10,3	10,3	10,3	10,3
Max water supply pressure	Bar	1÷8	1÷8	1÷8	1÷8	1÷8	1÷8	1÷8	1÷8	1÷8	1÷8	1÷8	1÷8	1÷8
NET WEIGHT (1)	kg	3	4	5	6	6	10	12	14	16	18	20	20	20
HYDRAULIC CONNECTION														
WATER INLET - ISO 228/1 – G M	Ø	3/4"	3/4"	3/4"	3/4"	3/4"	3/4"	3/4"	3/4"	3/4"	3/4"	3/4"	3/4"	3/4"
WATER OUTLET - external diameter	Ø mm	19	19	19	19	19	19	19	19	19	19	19	19	19

1. Value to be added to the weight of the standard unit. Does not include the weight of the water content.

(*) Only UNDER version



HUMIDIFIER OVERSIZED

The optional is not available for sizes E0, E7, E8, E9, E10.
On request, it is possible to install the oversized humidifiers.
The components are the same standard accessory

TECHNICAL DATA OVERSIZED HUMIDIFIER – w-NEXT S Over / Under

MODEL		007	013(1)	021(1)	032(1)	045	053	072	081	100	120	138	160	215
SIZE		E0	E1	E2	E3	E3P	E4	E5	E6	E7	E8	E9	E10	E10
VAPOUR PRODUCTION	kg/h	--	8,0	8,0	8,0	8,0	15,0	15,0	15,0	--	--	--	--	--
Power input	kW	--	6,0	6,0	6,0	6,0	11,3	11,3	11,3	--	--	--	--	--
Absorbed current (OA)	A	--	8,7	8,7	8,7	8,7	16,2	16,2	16,2	--	--	--	--	--
Max absorbed current (FLA)	A	--	12,4	12,4	12,4	12,4	23,0	23,0	23,0	--	--	--	--	--
Water content	l	--	6,4	6,4	6,4	6,4	10,3	10,3	10,3	--	--	--	--	--
Max water supply pressure	Bar	--	1÷8	1÷8	1÷8	1÷8	1÷8	1÷8	1÷8	--	--	--	--	--
NET WEIGHT (1)	kg	--	10	10	10	10	16	16	16	--	--	--	--	--
HYDRAULIC CONNECTION														
WATER INLET - ISO 228/1 – G M	Ø	--	3/4"	3/4"	3/4"	3/4"	3/4"	3/4"	3/4"	--	--	--	--	--
WATER OUTLET - external diameter	Ø mm	--	19	19	19	19	19	19	19	--	--	--	--	--

1. Only OVER version
2. Value to be added to the weight of the standard unit. Does not include the weight of the water content.

OPTIONAL ACCESSORIES – DEHUMIDIFICATION SYSTEM

Components:

- Temperature / Humidity sensor on the air intake.
- Temperature sensor on cooling coil water inlet / outlet.
- Electronic control system of the dew point temperature for the combined intervention of cooling capacity and air flow.

OPTIONAL ACCESSORIES – 2-WAY VALVE FOR BY-PASS

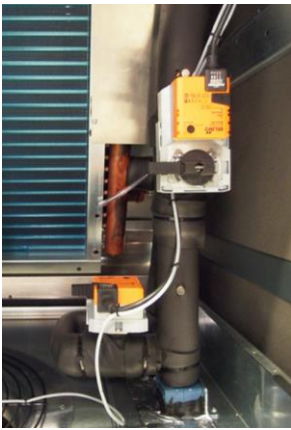

2-way motorized valve with 0÷10 VDC control actuator and emergency manual control for the third way (by-pass) of the hydraulic circuit.

The valve is in combination with the main 2-way water flow control valve.

The optional accessory is factory installed and don't modify the overall dimensions of the unit.

The coupling to the main 2-way control valve of a second modulating valve, connected in by-pass, allows to obtain the same control system of a 3-way mixing valve for plant with constant water flow.

At the same time the appropriate sizing of these valves allows hydraulic balancing of the by-pass way.

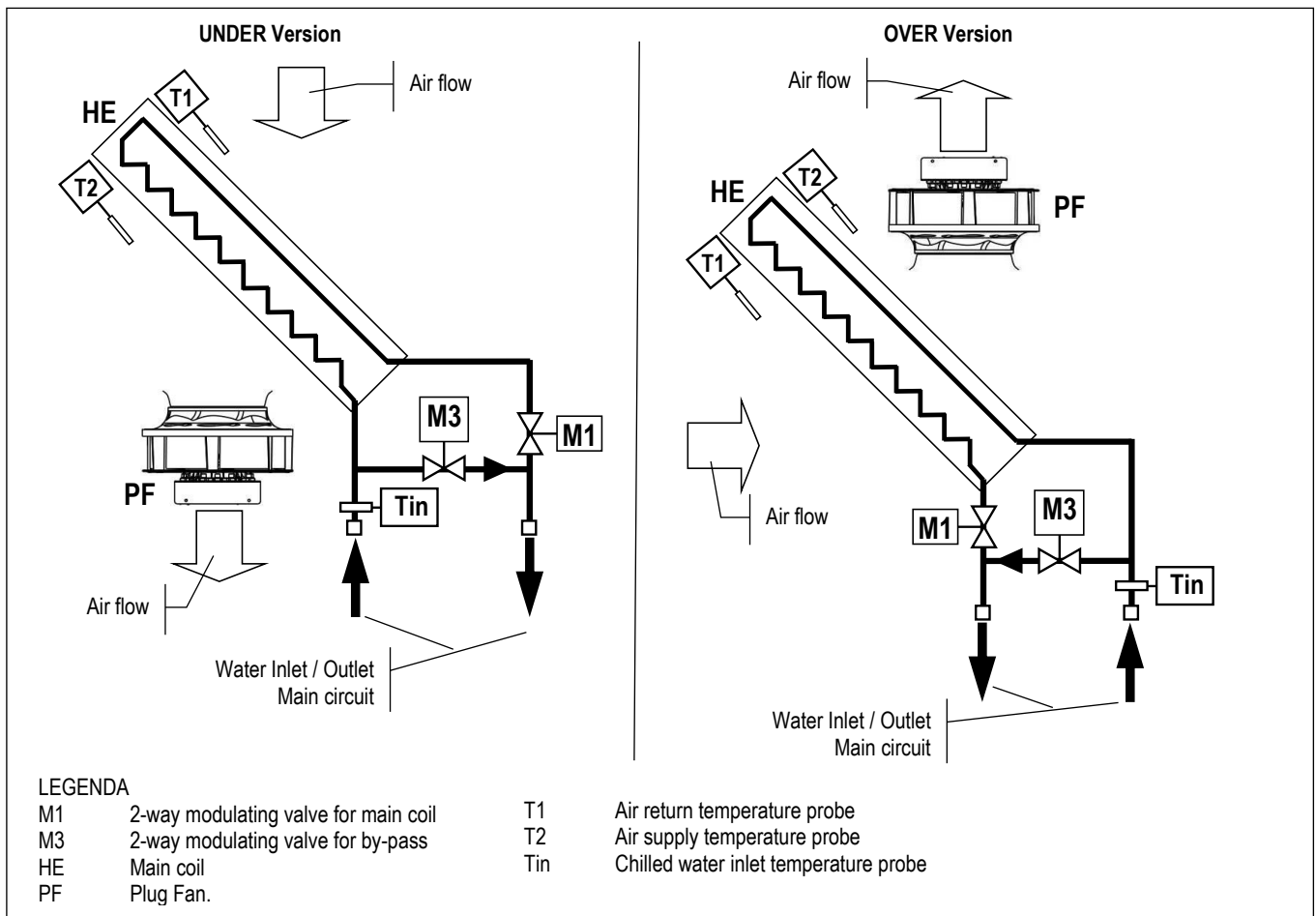

TECHNICAL DATA – 2-WAY VALVE FOR BY-PASS – w-NEXT S Over / Under

MODEL	007	013	021	032	045	053	072	081	100	120	138	160(*)	215(*)	
SIZE	E0	E1	E2	E3	E3P	E4	E5	E6	E7	E8	E9	E10	E10	
2-WAY VALVE FOR BY-PASS														
k_v – Flow coefficient	m ³ /h	(**)	4,0	4,0	6,3	8,6	8,6	16,0	16,0	16,0	25,0	25,0	25,0	40,0

(*) Only UNDER version

(**) Installation of a 3-way valve in place of a 2-way modulating valve for main coil (M1) and a 2-way modulating valve for by-pass (M3).

IMPORTANT

For further information, please refer to chapter “VALVE PRESSURE DROP CALCULATION AS FUNCTION OF WATER FLOW RATE”



OPTIONAL ACCESSORIES – ELECTRIC HEATERS



Electric heater consisting of finned aluminum elements, ensuring low surface temperature and deleting the air ionization problems. The optional is installed downstream the main cooling coil.

In electric heaters with three working steps the activation is binary type.

Components:

- Electric heater in aluminium armoured elements with integral fins
- Electrical control
- Safety thermostat.

TECHNICAL DATA ELECTRIC HEATERS – w-NEXT S Over / Under

MODEL		007	013	021	032	045	053	072
SIZE		E0	E1	E2	E3	E3P	E4	E5
THERMAL CAPACITY	kW	2,1	6,0	6,0	6,0	6,0	9,0	12,0
Absorbed current (OA)	A	3,0	8,7	8,7	14,3	14,3	13,0	17,3
First working step	kW	2,1	6,0	6,0	3,9	3,9	3,0	4,2
Second working step	kW	-	-	-	6,0	6,0	6,0	7,8
Third working step	kW	-	-	-	-	-	3,0+6,0	4,2+7,8
NET WEIGHT (1)	kg	2	5	8	10	13	15	18

MODEL		081	100	120	138	160 (*)	215 (*)
SIZE		E6	E7	E8	E9	E10	E10
THERMAL CAPACITY	kW	12,0	12,0	18,0	18,0	27,0	27,0
Absorbed current (OA)	A	17,3	17,3	26,0	26,0	39,0	39,0
First working step	kW	4,2	4,2	6,0	6,0	9,0	9,0
Second working step	kW	7,8	7,8	12,0	12,0	18,0	18,0
Third working step	kW	4,2+7,8	4,2+7,8	6,0+12,0	6,0+12,0	9,0+18,0	9,0+18,0
NET WEIGHT (1)	kg	21	23	25	30	35	40

ELECTRIC HEATERS OVERSIZED

On request, it is possible to install the oversized electric heating system.

The components are the same standard accessory

The optional is not available for size E0, E1 and E2.

TECHNICAL DATA OVERSIZED ELECTRIC HEATERS - w-NEXT S Over / Under

MODEL		007	013	021	032	045	053	072
SIZE		E0	E1	E2	E3	E3P	E4	E5
THERMAL CAPACITY	kW	--	--	--	9,0	9,0	12,0	18,0
Absorbed current (OA)	A	--	--	--	13,0	13,0	17,3	26,0
First working step	kW	--	--	--	6,0	6,0	4,2	6,3
Second working step	kW	--	--	--	9,0	9,0	7,8	11,7
Third working step	kW	--	--	--	-	-	4,2+7,8	6,3+11,7
NET WEIGHT (1)	kg	--	--	--	15	15	18	25

MODEL		081	100	120	138	160 (*)	215 (*)
SIZE		E6	E7	E8	E9	E10	E10
THERMAL CAPACITY	kW	18,0	18,0	27,0	27,0	36,0	36,0
Absorbed current (OA)	A	26,0	26,0	39,0	39,0	52,0	52,0
First working step	kW	6,3	6,3	9,0	9,0	12,0	12,0
Second working step	kW	11,7	11,7	18,0	18,0	24,0	24,0
Third working step	kW	6,3+11,7	6,3+11,7	9,0+18,0	9,0+18,0	12,0+24,0	12,0+24,0
NET WEIGHT (1)	kg	25	25	38	38	50	50

1. Value to be added to the weight of the standard unit.

(*) Only UNDER version

OPTIONAL ACCESSORIES – HOT WATER HEATING SYSTEM



The optional accessory is factory installed and don't modify the overall dimensions of the unit.
The optional is not compatible with "hot gas reheating system".
Hot water heating system installed downstream the main cooling coil.

Components:

- Heat exchanger coil with internally corrugated copper tubes and high efficiency aluminium fins, specifically developed to provide high heat transfer and lower pressure drops.
- 2-way motorized valve for water flow regulation with 0÷10 VDC control actuator and emergency manual control.
- Temperature probe on water inlet.
- Frame in galvanized steel.

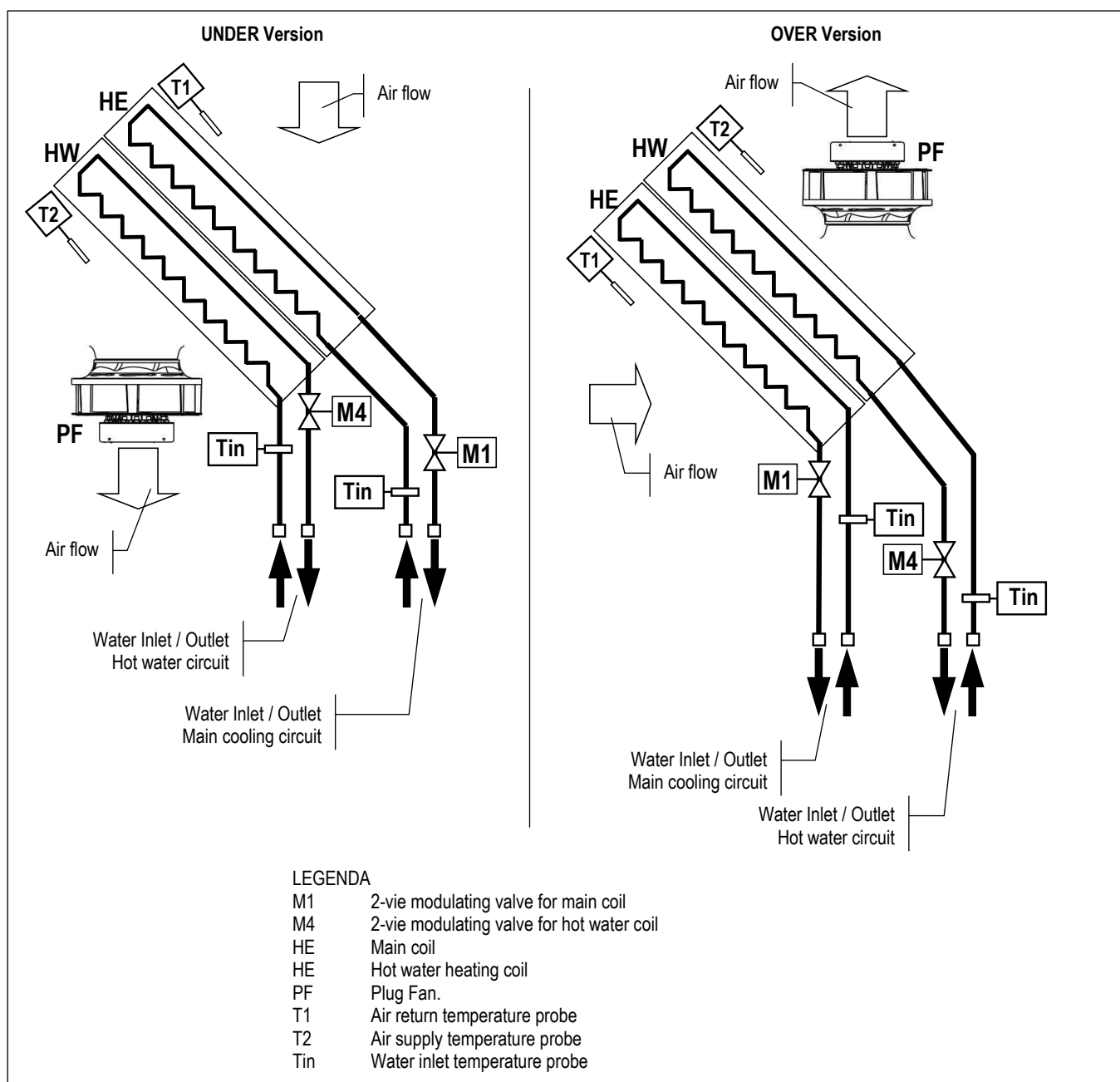

TECHNICAL DATA HOT WATER HEATING SYSTEM – w-NEXT S Over / Under

MODEL		007	013	021	032	045	053	072
SIZE		E0	E1	E2	E3	E3P	E4	E5
THERMAL CAPACITY (1)	kW	12,2	26,7	35,4	57,0	78,7	101,0	126,0
HEATING COIL								
Water flow rate (1)	m ³ /h	0,7	1,6	2,1	3,3	4,6	5,9	7,4
dP coil + valve (1)	kPa	14	33	26	37	51	23	38
Water volume	l	0,7	2,1	2,6	3,9	5,7	6,9	9,1
NET WEIGHT (2)	kg	8	15	18	25	30	35	42
HYDRAULIC CONNECTIONS								
WATER INLET / OUTLET	ISO 7/1 - R Ø	3/4"	3/4"	3/4"	1"	1"	1+1/4"	1+1/2"

MODEL		081	100	120	138	160 (*)	215 (*)
SIZE		E6	E7	E8	E9	E10	E10
THERMAL CAPACITY (1)	kW	155,0	181,0	190,0	236,0	--	--
HEATING COIL							
Water flow rate (1)	m ³ /h	9,1	10,6	11,1	13,8	--	--
dP coil + valve (1)	kPa	41	24	27	43	--	--
Water volume	l	10,6	12,3	14,2	16,9	--	--
NET WEIGHT (2)	kg	50	57	65	75	--	--
HYDRAULIC CONNECTIONS							
WATER INLET / OUTLET	ISO 7/1 - R Ø	1+1/2"	2"	2"	2"	--	--

1. Characteristics referred to entering air at 20°C with hot water temperature 75/60°C - 0% glycol.
2. Value to be added to the weight of the standard unit. Does not include the weight of the water content.

OPTIONAL ACCESSORIES - FLOOR STAND

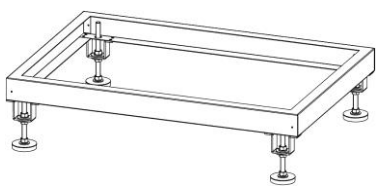

It is not possible to match the unit floor stand with plenum installed under the machine.
 For a correct installation of the air conditioner we suggest you to utilize a gasket between the floor stand and the unit base.
 The floor stand is available in 3 different heights.

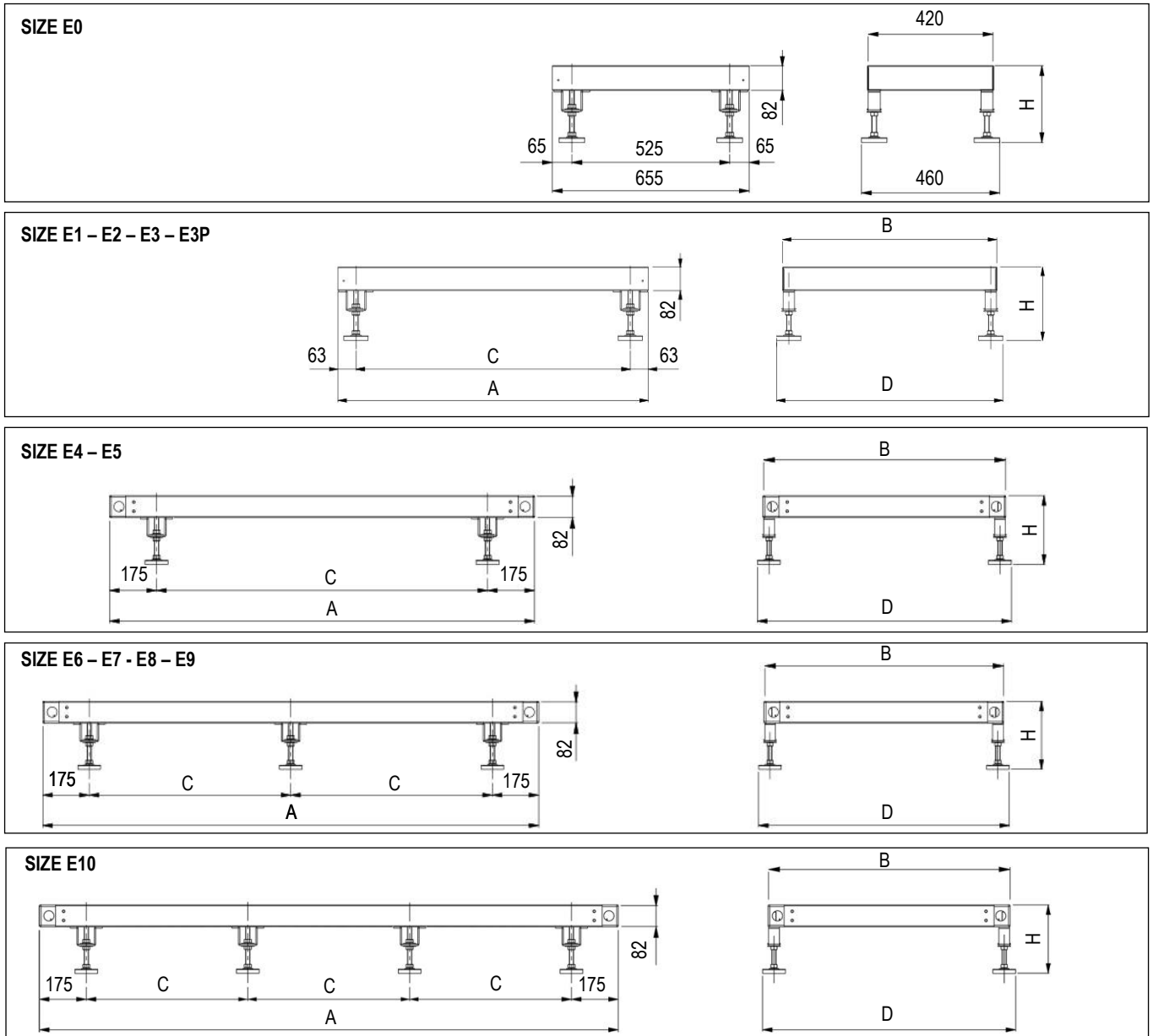

SIZE		E0	E1	E2	E3	E3P	E4	E5	E6	E7	E8	E9	E10
A	mm	655	650	785	1085	1085	1305	1630	1873	2175	2499	2899	3510
B	mm	420	650	650	750	905	905	905	905	905	905	905	905
C	mm	525	524	659	959	959	955	1280	761,5	912,5	1074,5	1274,5	1053
D	mm	460	691	691	791	946	945	945	945	945	945	945	945

MODEL		Hmax350	Hmax450	Hmax510
H min height	mm	255	355	400
H max height	mm	350	450	510



OPTIONAL ACCESSORIES - DOUBLE PANELS IN EUROCLASS A1

The optional is designed to supply the panels only in Euroclass A1 of reaction to fire, furthermore allows a noise insulation of the panels of the air conditioners.

The pressure level reduction of the unit is about 2 dB(A). The reduction refers ONLY to the sound level radiated from the unit or in front of the unit. The noise level data on return and delivery air do not undergo reductions.

The accessory includes:

- External part as standard panel.
- Internal part in galvanized steel sheet.
- The inside noise insulation with special soundproof material.

REACTION TO FIRE CLASSIFICATION

On Italian territory, the classification is per the D.M. of June 26, 1984 and subsequent amendments, providing for a sort in "Classes" from 0 (non-combustible material) to 5 (extremely flammable material). In Europe, the classification is regulated per UNI EN 13501-1: 2009 ordered to "Euro-classes", from A1 (non-combustible material) to F (highly flammable material).

A comparison of the Italian and European classes is not possible because the methods and evaluation criteria are completely different. The comparison table below is being considered purely indicative.

Definition	Italian classes	Euro-classes
Non-combustible material	Class 0	A1
Combustible material, very limited contribution to fire	Class 1	A2 – B
Combustible material, limited contribution to fire	Class 2	A2 – B - C
Combustible material, medium contribution to fire	Class 3	C – D
Combustible material, highly contribution to fire	Class 4	E
Combustible material, easily flammable	Class 5	F

Is possible to provide the sandwich panels for the OVER units with air flow from the top. This implies that the air intake must necessarily be from the base of the unit with front blind paneling.

The accessory increases the unit weight:

OVER													
Size		E0	E1	E2	E3	E3P	E4	E5	E6	E7	E8	E9	E10
Weight increasing (1)	kg	25	26	42	48	58	64	72	86	100	115	130	--

UNDER													
Size		E0	E1	E2	E3	E3P	E4	E5	E6	E7	E8	E9	E10
Weight increasing (1)	kg	25	30	48	55	65	70	86	110	130	145	165	195

1. Add this value to the total unit weight

OPTIONAL ACCESSORIES – M5 EFFICIENCY AIR FILTERS

The optional is not available for size E0.
The M5 air filters replace the standard one.
The filters M5 generate a pressure drops higher than the standard ones.
The filters are made of glass micro fibre and are not regenerable.

w-NEXT S Over / Under

MODEL		007	013	021	032	045	053	072	081	100	120	138	160(*)	215(*)
SIZE		E0	E1	E2	E3	E3P	E4	E5	E6	E7	E8	E9	E10	E10
Perdita di carico addizionale (1)	Pa	--	58	78	102	94	68	65	73	77	60	78	63	63

1. Additional pressure drops referred to nominal air flow and clean filter.
- (*) Only UNDER version

OPTIONAL ACCESSORIES – NON-RETURN MOTORIZED DAMPER

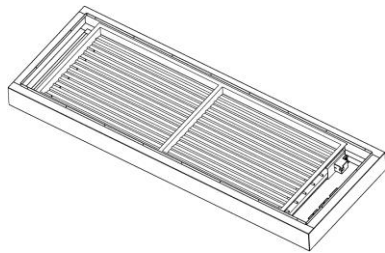

Accessory installed on units air delivery or return and it can be matched to plenums and floor stand.

FRAMEWORK

- Frame in galvanized steel sheet with protective surfaces treatment in compliance with UNI ISO 9227/ASTMB117 and ISO 7253, and painted with epoxy powders. Colour RAL 9005;
- Opposed blade dampers in galvanized steel sheet.
- Actuator for damper control.
- Terminals for electric connection to the unit.

For a correct installation, we suggest you to utilize a gasket between the damper and the plenum or the floor stand.

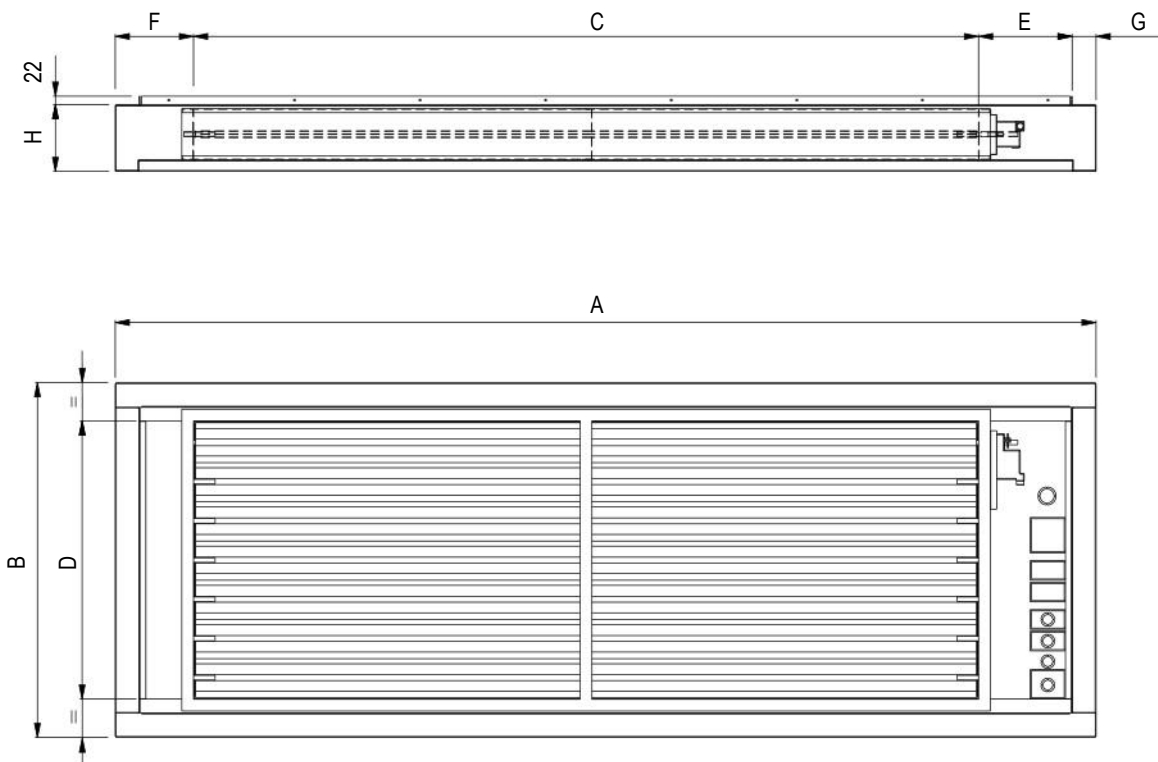

Size		E0	E1	E2	E3	E3P	E4	E5	E6	E7	E8	E9	E10(*)
A	mm	655	650	785	1085	1085	1305	1630	1873	2175	2499	2899	3510
B	mm	420	650	650	750	905	905	905	905	905	905	905	905
C	mm	445	300	450	750	750	900	1250	1500	1750	2000	2300	2800
D	mm	310	510	510	610	710	710	710	710	710	710	710	710
E	mm	118	231	216	216	216	142	204	250,5	226,5	238,5	288,5	294
F	mm	57	73	73	73	73	202	115	61,5	137,5	199,5	249,5	355
G	mm	30	46	46	46	46	61	61	61	61	61	61	61
H	mm	190	170	170	170	170	170	170	170	170	170	170	170
Weight (1)	kg	13	20	23	30	35	40	50	58	65	75	90	115

1. Add this value to the total unit weight
(*) Only UNDER version

INSTALLATION EXAMPLE

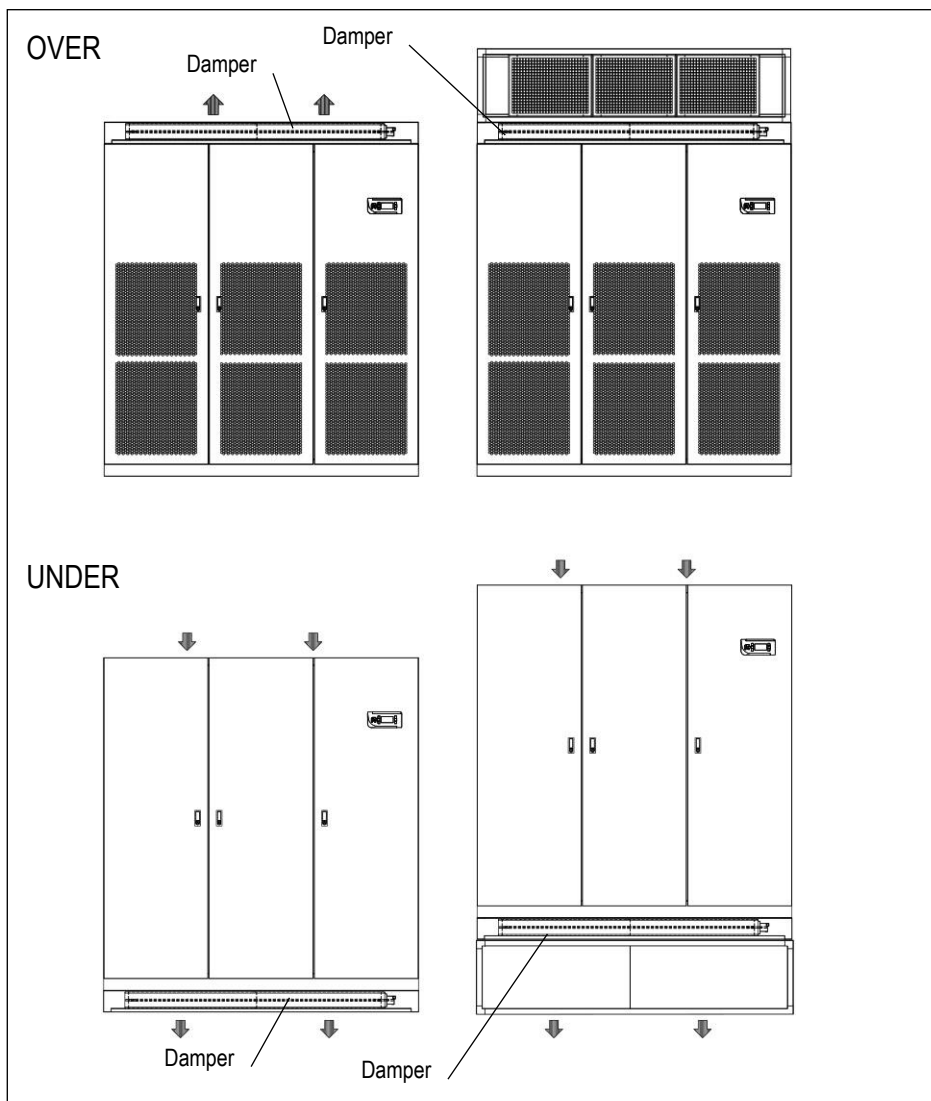

WORKING LOGIC

The damper opens at supply fans activation to allow air flow.

When the fans stop for failure or stop command, the damper closes, preventing air flow into the unit.

OPTIONAL ACCESSORIES - PLENUM ON AIR DELIVERY/RETURN

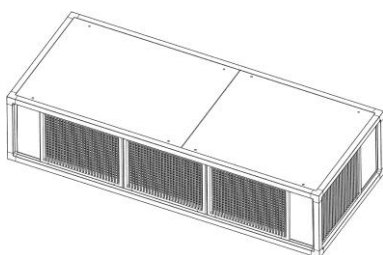
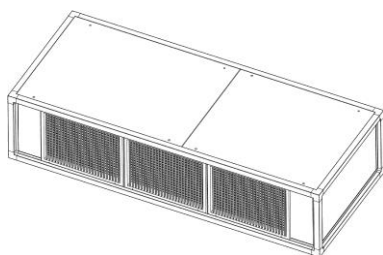
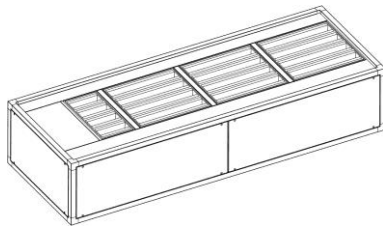
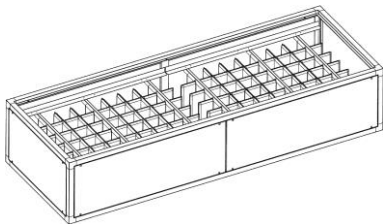
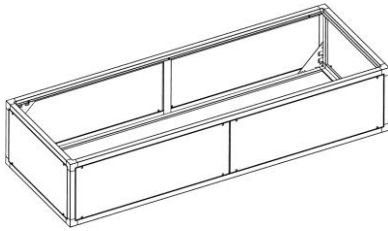

The plenums can be used for versions Over and Under, both on supply and return air. The plenums have same technical characteristics and dimensions of the machine cabinet.

It is possible to install only a single plenum to ensure stability to the unit.

FRAMEWORK

- Frame in aluminium extrusion, painted with epoxy powders. Colour RAL 9005;
- Panels in galvanized steel sheet with protective surfaces treatment in compliance with UNI ISO 9227/ASTMB117 and ISO 7253, and painted with epoxy powders. Colour RAL 9005;
- Panels insulated with polyurethane foam and seals to ensure air tight.
- Panels fixed with screws.
- Removable panels.
- Set of fixing elements to fasten the plenum to the unit.

Type of plenum:

- Empty plenum. Available in Euroclass A1.
- Plenum with noise absorption partitions
- Plenum with high efficiency filters.
- Plenum with frontal grille. Available in Euroclass A1.
- Plenum with frontal and lateral grilles. Available in Euroclass A1.
- Plenum with frontal grille and noise absorption partitions

WARNING

In UNDER version units the hydraulic piping is inside the machine.

The air delivery plenums sometime don't allow the extension of the pipes downwards.

In special cases, to keep the connections inside the machine, foresee a plenum 200mm higher than the standard one.

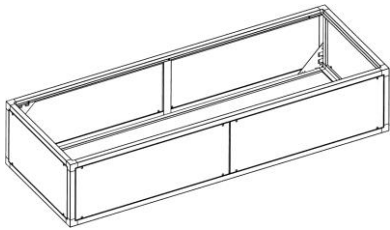

EMPTY PLENUM

The optional is not available for size E0.

The plenum is void and can be used to rise the return air inlet/outlet.

Remove the frontal panels for inspection.

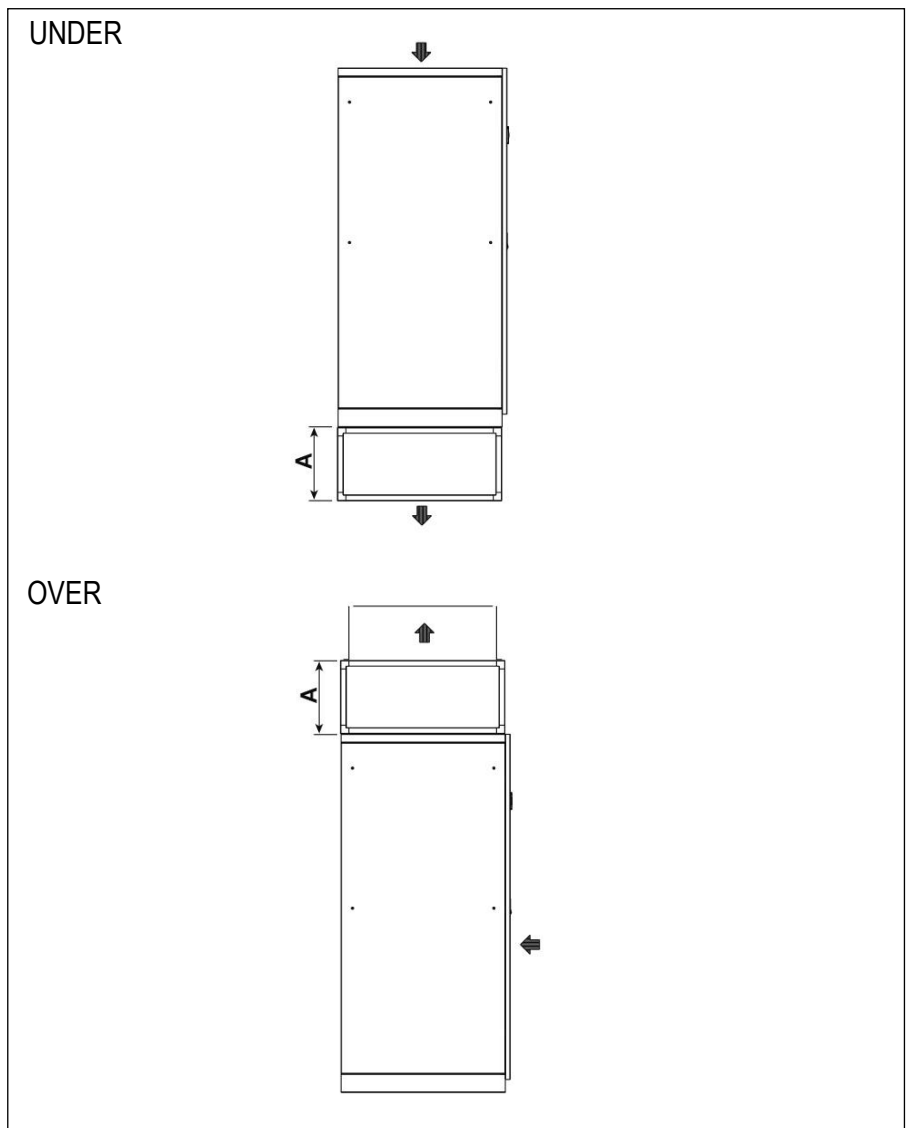

SIZE		E0	E1	E2	E3	E3P	E4	E5	E6	E7	E8	E9	E10(*)
A	mm	--	490	490	490	510	510	510	510	510	510	510	510
Weight (1)	kg	--	20	21	20	25	30	40	45	50	60	70	78

1. Add this value to the total unit weight
- (*) Only UNDER version

EMPTY PLENUM

REACTION TO FIRE – EUROCLASS A1

SIZE		E0	E1	E2	E3	E3P	E4	E5	E6	E7	E8	E9	E10(*)
A	mm	--	490	490	490	510	510	510	510	510	510	510	510
Weight (1)	kg	--	25	27	27	33	39	50	56	62	74	85	96

1. Add this value to the total unit weight
- (*) Only UNDER version

PLENUM ON AIR DELIVERY WITH NOISE ABSORPTION PARTITIONS

The optional is not available for size E0.

The plenum is fitted with noise absorption partitions to reduce the noise emission. Remove the frontal panels for inspection.

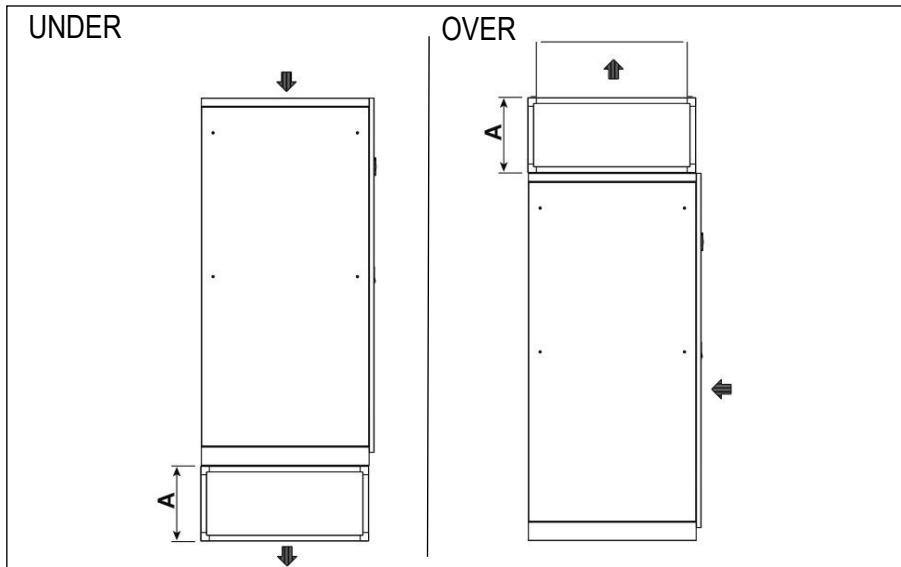
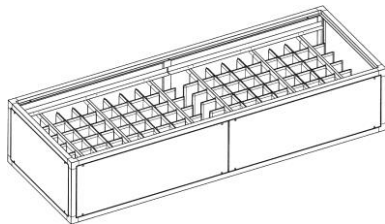

SIZE		E0	E1	E2	E3	E3P	E4	E5	E6	E7	E8	E9	E10(*)
A	mm	--	490	490	490	510	510	510	510	510	510	510	510
Weight (1)	kg	--	25	27	30	36	45	50	65	80	90	100	120

1. Add this value to the total unit weight

(*) Only UNDER version

w-NEXT S

MODEL		007	013	021	032	045	053	072	081	100	120	138	160(*)	215(*)
SIZE		E0	E1	E2	E3	E3P	E4	E5	E6	E7	E8	E9	E10	E10
NOISE LEVEL (1)														
On air delivery Under	dB(A)	--	62,1	70,6	72,0	74,5	75,1	75,5	75,9	76,9	80,3	79,8	79,1	79,1
On air intake Under	dB(A)	--	56,0	60,9	62,1	66,2	66,7	65,6	67,5	68,5	70,4	71,4	70,7	70,7
On front side Under	dB(A)	--	46,7	51,4	52,5	56,7	57,2	56,0	58,1	59,0	60,8	61,9	61,2	61,2
On air delivery Over	dB(A)	--	62,1	70,6	72,0	74,5	75,1	75,5	75,9	76,9	80,3	79,8	--	--
On air intake Over (2)	dB(A)	--	50,8	55,3	56,6	60,7	61,2	60,1	62,1	63,0	64,9	62,6	--	--
On front side Over (3)	dB(A)	--	46,7	51,4	52,5	56,7	57,2	56,0	58,1	59,0	60,8	58,6	--	--
Additional pressure drops (4)	Pa	--	24	29	48	60	64	63	72	79	61	82	131	131
Air flow	m ³ /h	--	2850	4800	7800	10800	13100	16350	20000	24200	28300	33100	37150	37150

1. Noise pressure level at 1 meter in free field – ISO 3744

2. Air intake from the front

3. Air intake from the bottom

4. Value to be subtracted from the nominal external static pressure of the unit.

(*) Only UNDER version

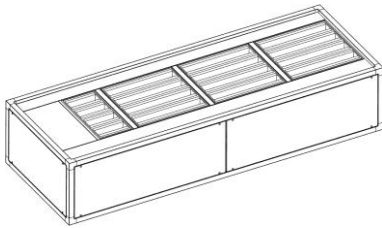

PLENUM ON AIR DELIVERY WITH HIGH EFFICIENCY FILTERS

The optional is not available for size E0.

The plenum must be installed on air delivery.

The plenum is fitted with high efficiency rigid bag filters.

Filters are made of glass micro fibre and are not regenerable.

Remove the frontal panels for filters replacement.

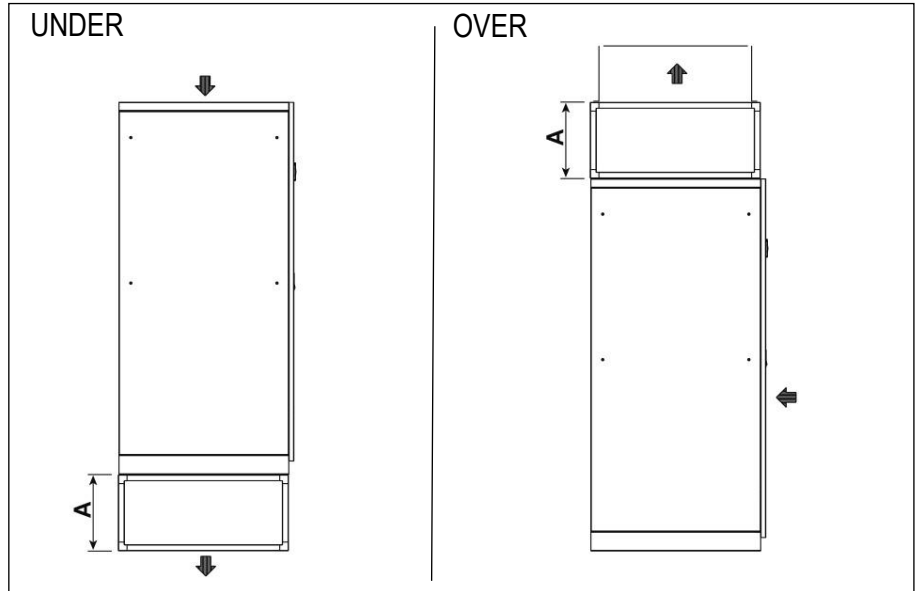

SIZE		E0	E1	E2	E3	E3P	E4	E5	E6	E7	E8	E9	E10(*)
A	m	--	490	490	490	510	510	510	510	510	510	510	510
Weight (1)	kg	--	26	27	30	33	45	55	65	80	90	100	120
PRESSURE DROPS (2)													
Filters M6	Pa	--	59	122	145	125	137	152	185	165	160	184	145
Filters F7	Pa	--	72	150	177	158	168	187	227	202	186	225	197
Filters F9	Pa	--	87	182	215	190	204	227	275	245	238	273	216

1. Add this value to the total unit weight
 2. Data referred to the nominal air flow and clean filters. Value to be subtracted from the nominal external static pressure of the unit.
- (*) Only UNDER version

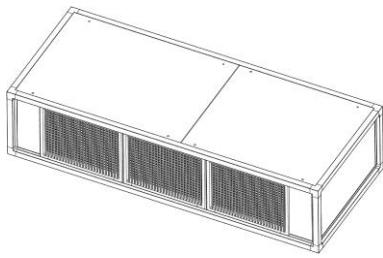

PLENUM ON AIR DELIVERY WITH FRONTAL GRILLE

The plenum allows the frontal air distribution directly into the room.

The plenum is supplied with air distribution grille with double row adjustable grilles on front side.

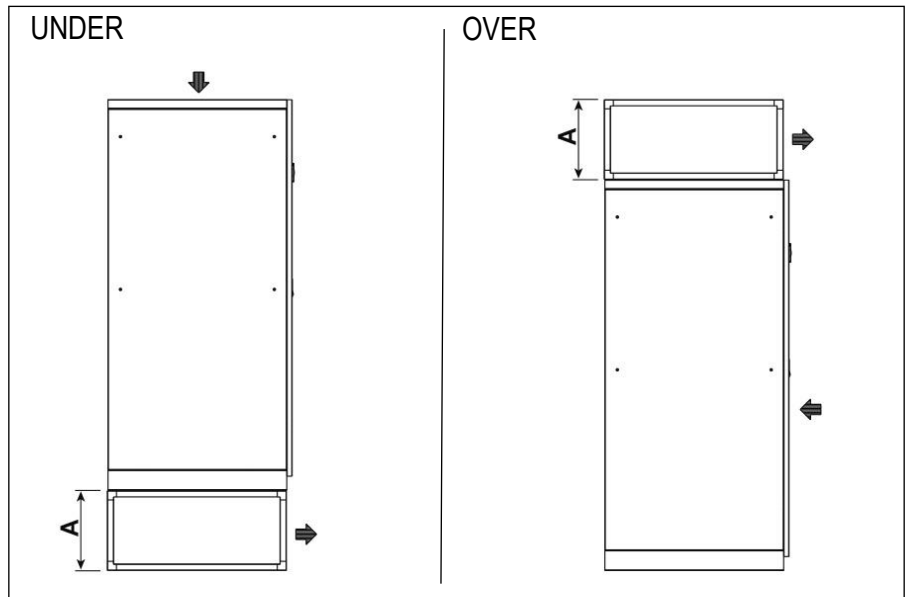

SIZE		E0	E1	E2	E3	E3P	E4	E5	E6	E7	E8	E9	E10(*)
A	mm	490	490	490	490	510	510	510	510	510	510	510	510
Weight (1)	kg	15,5	23	26	28	34	39	50	65	75	90	110	130

1. Add this value to the total unit weight
- (*) Only UNDER version

PLENUM ON AIR DELIVERY WITH FRONTAL GRILLE REACTION TO FIRE – EUROCLASS A1

SIZE		E0	E1	E2	E3	E3P	E4	E5	E6	E7	E8	E9	E10(*)
A	mm	490	490	490	490	510	510	510	510	510	510	510	510
Weight (1)	kg	20	29	32	36	44	50	63	79	91	108	130	153

1. Add this value to the total unit weight
- (*) Only UNDER version

PLENUM ON AIR DELIVERY WITH FRONTAL AND LATERAL GRILLES

The plenum allows the air distribution directly into the room.

The plenum is supplied with air distribution grilles with double row adjustable grilles on front and lateral side.

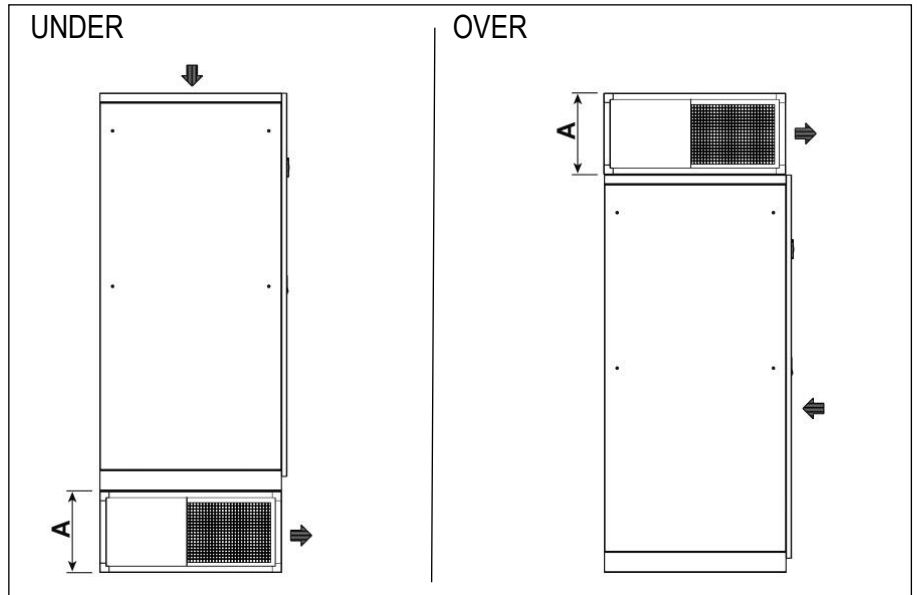
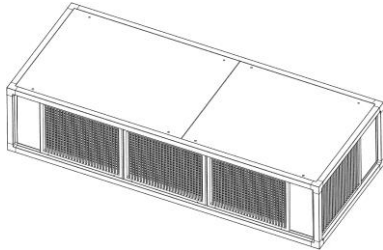

SIZE		E0	E1	E2	E3	E3P	E4	E5	E6	E7	E8	E9	E10(*)
A	mm	490	490	490	490	510	510	510	510	510	510	510	510
Weight (1)	kg	15	21	23	30	36	45	50	65	75	90	100	120

1. Add this value to the total unit weight
(*) Only UNDER version

PLENUM ON AIR DELIVERY WITH FRONTAL AND LATERAL GRILLES REACTION TO FIRE – EUROCLASS A1

SIZE		E0	E1	E2	E3	E3P	E4	E5	E6	E7	E8	E9	E10(*)
A	mm	490	490	490	490	510	510	510	510	510	510	510	510
Weight (1)	kg	18	25	28	37	44	54	61	77	89	106	118	142

1. Add this value to the total unit weight
(*) Only UNDER version

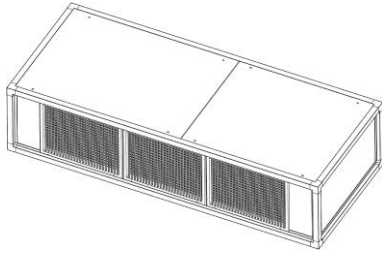

PLENUM ON AIR DELIVERY WITH FRONTAL GRILLE AND NOISE ABSORPTION PARTITIONS

The optional is not available for Under version.

The plenum allows the frontal air distribution directly into the room and a noise reduction of the air delivery.

The plenum is supplied with air distribution grille with double row adjustable grilles on front side and noise absorption partitions,

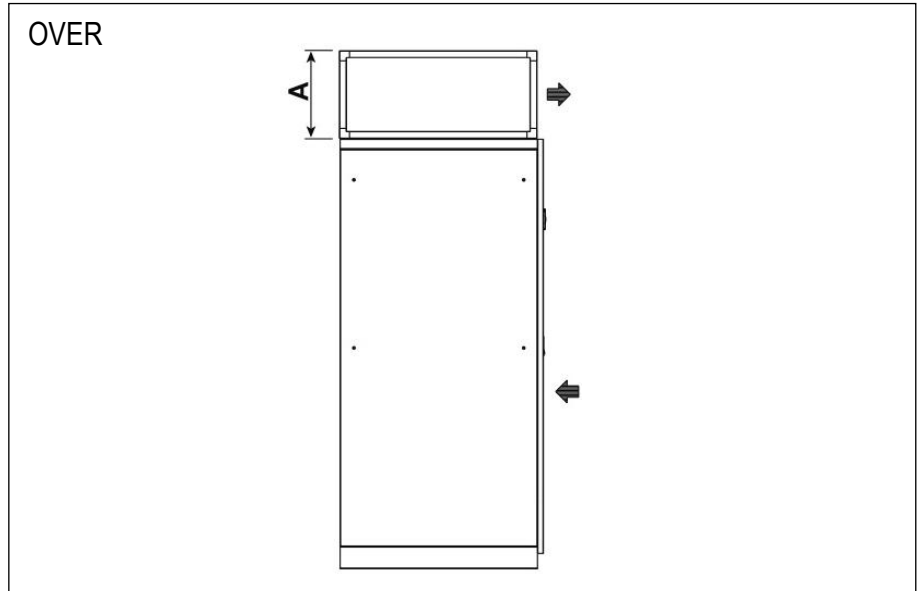

w-NEXT S

SIZE		E0	E1	E2	E3	E3P	E4	E5	E6	E7	E8	E9	E10
A	mm	--	490	490	490	510	510	510	510	510	510	510	--
Weight (1)	kg	--	30	30	37	45	67	72	78	88	110	130	--
SOUND LEVEL (2)													
On air delivery Over	dB(A)	--	60,0	70,5	71,7	74,0	73,8	75,1	75,4	76,1	79,3	78,8	--
On air intake Over (3)	dB(A)	--	50,1	55,4	57,0	60,8	60,6	60,4	62,2	62,9	64,6	62,6	--
Irradiated Over (4)	dB(A)	--	46,0	51,5	52,9	56,8	56,6	56,3	58,2	58,9	60,5	58,6	--
Additional pressure drops (5)	Pa	--	60	100	118	150	159	157	178	196	180	204	--
Air flow	m ³ /h	--	2700	4650	7800	10800	12500	16350	20000	23200	27500	32500	--

1. Add this value to the total unit weight
2. Noise pressure level at 1 meter in free field – ISO 3744
3. Air intake from the front
4. Air intake from the bottom
5. Value to be subtracted from the nominal external static pressure of the unit

OPTIONAL ACCESSORIES – DIRECT FREE-COOLING PLENUM

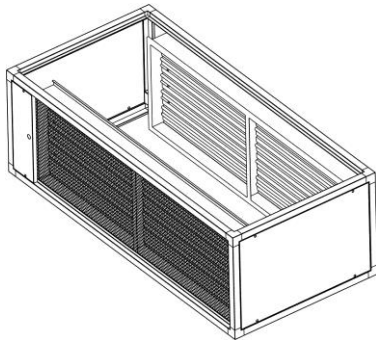
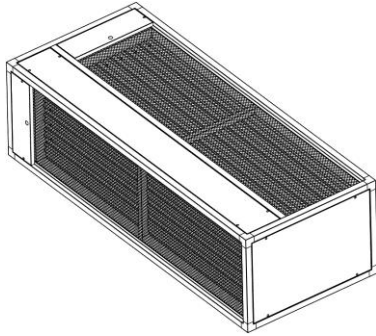

The optional is not available for size E0.

The plenums have same technical characteristics and base dimensions of the machine cabinet.

The optional allow to obtain free-cooling by direct ambient air intake into the room.

The dampers are proportionally managed by the microprocessor control, that regulates the quantity of the ambient air to put in the room according to the set-point.

COMPONENTS

- Frame in aluminium extrusion, painted with epoxy powders. Colour RAL 9005;
- Panels in galvanized steel sheet with protective surfaces treatment in compliance with UNI ISO 9227/ASTMB117 and ISO 7253, and painted with epoxy powders. Colour RAL 9005;
- Panels insulated with polyurethane foam and seals to ensure air tight.
- Panels fixed with screws.
- Removable panels.
- Opposed blade dampers in galvanized steel sheet and safety grille for ambient air and room air suction.
- Actuator for each damper.
- Terminals for electric connection to the unit.
- Combined Temperature / Humidity sensor on machine air suction. The sensor must be moved outside the air conditioners for a proper read of the room temperature value.
- Temperature sensor for outdoor air. The sensor must be installed in the outdoor air suction duct or anyway protected against atmospheric agent.
- Free contact for free-cooling operating status monitoring.
- Set of fixing elements to fasten the plenum to the unit.

For a correct installation use a gasket between the plenum and the unit.

WARNING

IT IS COMPULSORY TO INSTALL INTO THE ROOM AN APPROPRIATELY SIZED OVERPRESSURE DAMPER TO ALLOW THE ROOM AIR EXHAUSTION DURING FREE-COOLING WORKING MODE.

ESEMPIO DI INSTALLAZIONE

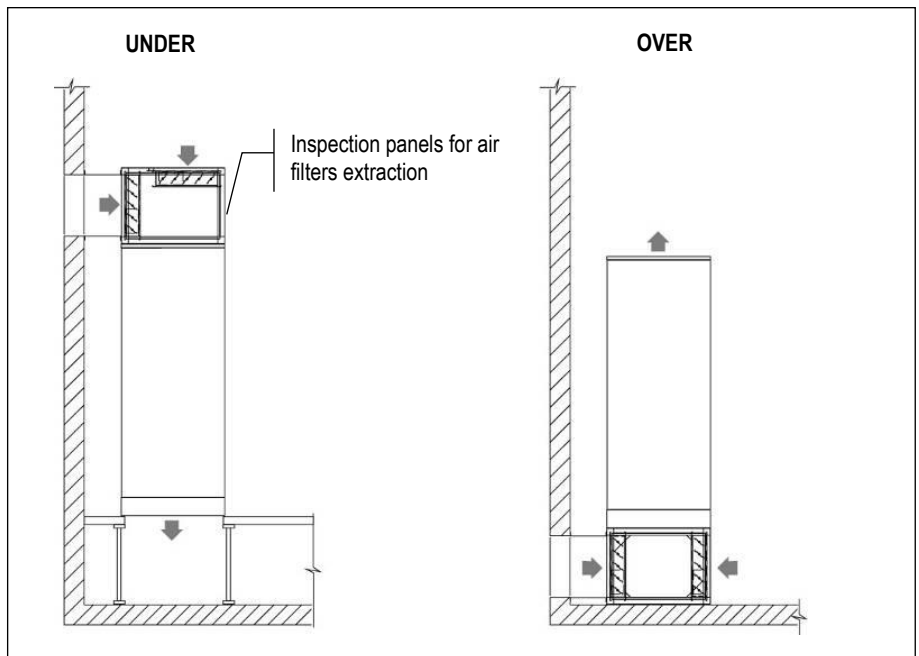

Ducting are at Customer care.

We suggest you to install a rain-proof grille on ambient air intake.

OVER VERSION

Size E1 / E2 / E3 / E3P

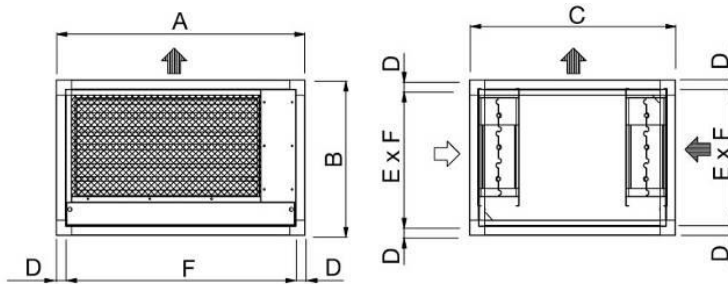

Size E4 / E5

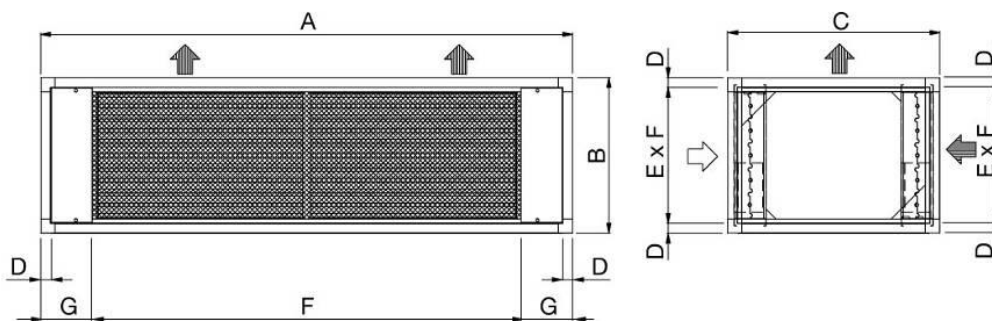

Size E6 / E7 / E8 / E9 / E10

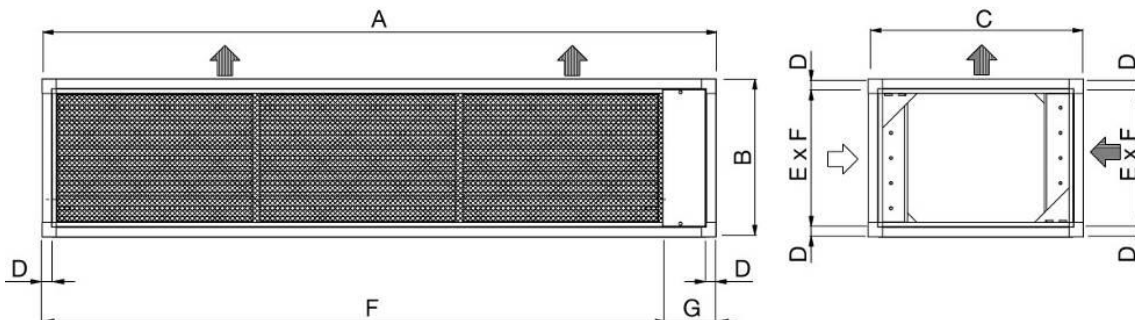

Size		E0	E1	E2	E3	E3P	E4	E5	E6	E7	E8	E9	E10
A	mm	--	650	785	1085	1085	1305	1630	1873	2175	2499	2899	--
B	mm	--	490	490	490	630	630	630	630	630	630	630	--
C	mm	--	650	650	750	905	905	905	905	905	905	905	--
D	mm	--	30	30	30	40	40	40	40	40	40	40	--
E	mm	--	430	430	430	550	550	550	550	550	550	550	--
F	mm	--	590	725	1025	1005	1035	1335	1664	1965	2220	2670	--
G	mm	--	--	--	--	--	135	147,5	209	210	279	229	--
Weight (1)	kg	--	24	27	35	43	53	61	78	90	110	130	--

1. Add this value to the total unit weight

UNDER VERSION

SIZE E1 / E2 / E3 / E3P

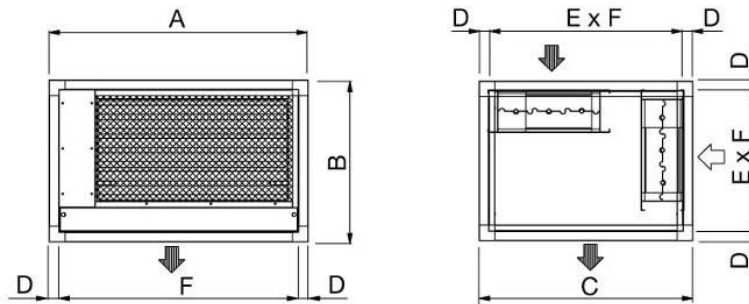

SIZE E4 / E5

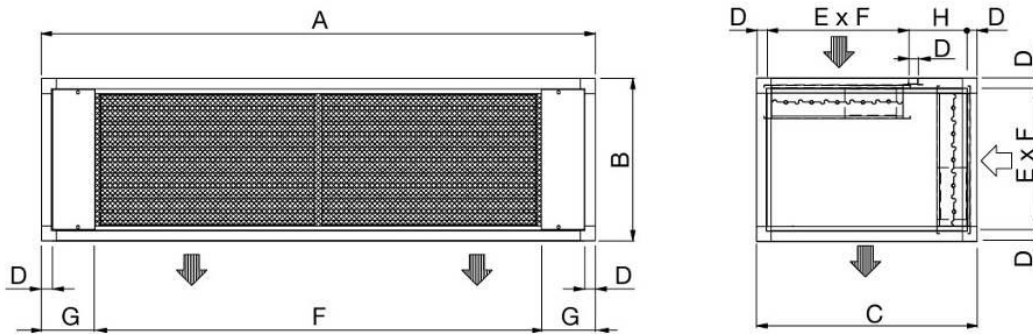

SIZE E6 / E7 / E8 / E9 / E10

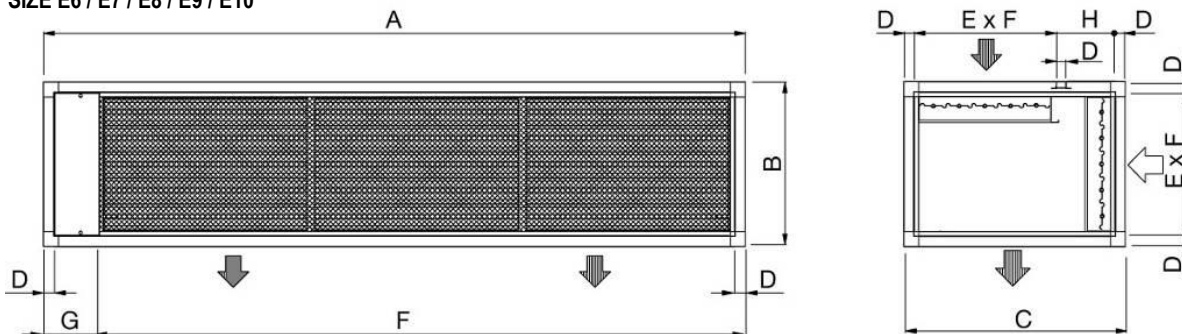

Size		E0	E1	E2	E3	E3P	E4	E5	E6	E7	E8	E9	E10
A	mm	--	650	785	1085	1085	1305	1630	1873	2175	2499	2899	3510
B	mm	--	490	490	490	630	630	630	630	630	630	630	630
C	mm	--	650	650	750	905	905	905	905	905	905	905	905
D	mm	--	30	30	30	40	40	40	40	40	40	40	40
E	mm	--	430	430	430	550	550	550	550	550	550	550	550
F	mm	--	590	725	1025	1005	1035	1335	1664	1965	2220	2670	3135
G	mm	--	--	--	--	--	135	147,5	209	210	279	229	375
H	mm	--	--	--	--	275	275	275	275	275	275	275	275
Weight (1)	kg	--	24	27	35	43	53	61	78	90	110	130	155

1. Add this value to the total unit weight

OPTIONAL ACCESSORIES – BOTTOM PANEL FOR OVER VERSION

Available for OVER units (size E0 excluded).

With this accessory, it is possible a noise insulation of the machine base, when the machine is installed directly on particular floor as raised floor, wood floor etc.

The accessory includes:

- Panel in galvanized steel sheet.
- Noise insulation with special soundproof material.

The bottom panel is supplied assembled inside the unit base and does not modify the unit dimensions.

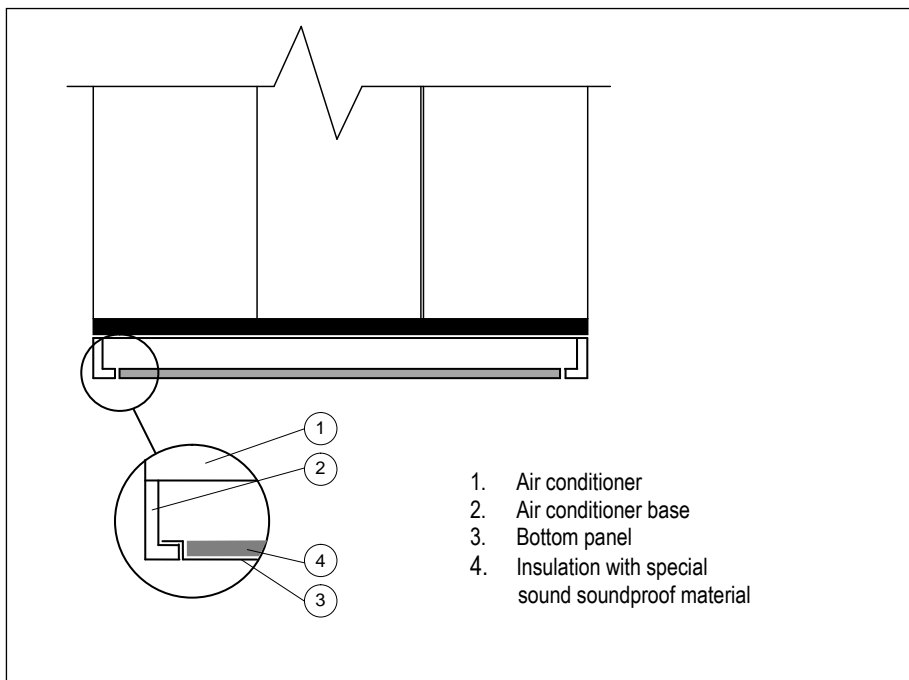

OPTIONAL ACCESSORIES – COOLNET



COOLNET: Intelligent NET for IT Cooling that maximizes the energy saving in LOAD SHARING

MAIN FEATURES

COOLNET is a software that applies to chilled water air conditioners microprocessor control system. It optimizes the LOAD SHARING working mode and maximizes the energy savings.

OPTIONAL ACCESSORIES – ADAPTIVE SET-POINT



ADAPTIVE SET-POINT

An advanced algorithm that instantaneously detects the real thermal load of the indoor units and then conveys this information to the outdoor chillers, strongly increasing their operation.

- Dynamic variation of the chillers set point and water flow.
- Increasing of the free cooling mode.
- Adoption of the active redundancy system to better exploit stand-by chillers.

DATA CENTER MANAGER (Optional accessory)

DATA CENTER MANAGER is a centralized management system that ensures a smart communication between indoor chilled water units and the outdoor chillers.

The device manages the outdoor units according to the inlet and outlet temperature registered by the probes and by request of the indoor unit.

OPTIONAL ACCESSORIES – KIPlink – Keyboard in your Pocket



KIPlink - Keyboard In Your Pocket - is the innovative user interface based on WiFi technology that allows one to operate on the unit directly from the smartphone or tablet. Using KIPlink, it is possible to turn the unit on and off, adjust the set-point, plot the main operating variables, monitor in detail the status of the refrigerant circuits, the compressors, the fans and display and reset the possible alarms.

Scan the QR code on the electrical board of the unit to have access to the unit control through web browser web or App. The access is possible within the local WiFi network.

KIPlink hardware:

- Wi-Fi antenna in the electrical board;
- ON/OFF button with power LED and Unit status LED. Provided when the unit is equipped with KIPlink and without 6-keys keyboard (optional).

KIPlink allows;

- Easy and enhanced unit management
- Real-Time graphs and key trends
- Different information for each kind of user

OPTIONAL ACCESSORIES – RC CLOUD PLATFORM: WEB SERVICES BASED ON CLOUD TECHNOLOGY FOR REMOTE MONITORING AND MANAGEMENT OF AIR CONDITIONING PLANTS.



Log-in to the web site
<http://rccloudplatform.rcgroup.it>
 automatic language recognition

RC Cloud Platform is an ecosystem of web services for remote monitoring and management of air conditioning plants; specifically designed for mobile usage on tablets and smartphones, it allows to access plant data everywhere on the go so saving time, money and delivering a higher service level to the customer.

TECHNOLOGY

Based on cloud technology it allows, through machines data telemetry, to monitor and control units on the field, process data and perform proactive maintenance.

The hardware heart of the system is the RC Cloud box that can collect plant data (up to 31 devices and up to 1000 registers).

Connectivity between monitored devices and RC Cloud box may be wired in Ethernet, RS485, RS232 and must be in MODBUS protocol.

RC Cloud Platform then send these data to dedicated server in cloud in through the mobile (GPRS or 3G) network or ADSL.

RC considers with great attention the security of customer information, so every communication channel may be encrypted in VPN, guaranteeing privacy and typical security policies commitment.

USER SIDE

RC Cloud Platform is designed for mobile communication. So the user just need a tablet or a smartphone to access the RC Cloud Platform and check his plant.

RC Cloud Platform App is available both on Android and iOS operating systems so the environment may be accessed directly from them beyond company site and platform site (<http://rccloudplatform.rcgroup.it>). Access through pc is available too.

FUNCTIONS

Telemetry & Data Export

Data polling and history of all data (1 year).
 Export diagram and table (csv). **Your data always on the go.**

Multi Device

Many type of devices can be connected to the same box (chillers, close control, energy meters, flow meters, pumps,...).
 Only a request: MODBUS protocol. Electrical connection in Ethernet, RS 485 or RS 232.

Multi Language

English native, RC Cloud Platform language pack is available for the main markets.

Virtual Display

Monitoring and control (on/off, alerts reset, main parameters change) as being beside the unit, in an augmented reality way.
 Designed for Mobile.

Same as standing in front of the unit, when in your office or in any other place.

Internet Connectivity

ETHERNET + GPRS + 3G connection capability on Public and Virtual Private Network (VPN).
 Your security and privacy are a top priority.

Alerts Warning through:

- Push notification
- e-mail
- Voice calls
- SMS

Processing of specialized plant KPI to get:

- Energy performance (gross instant EER)
- Components Failure Forecast (coming soon)
- Unit diagnosis

MACHINE DRAWINGS

Dimensions in mm - w-NEXT S Under E0

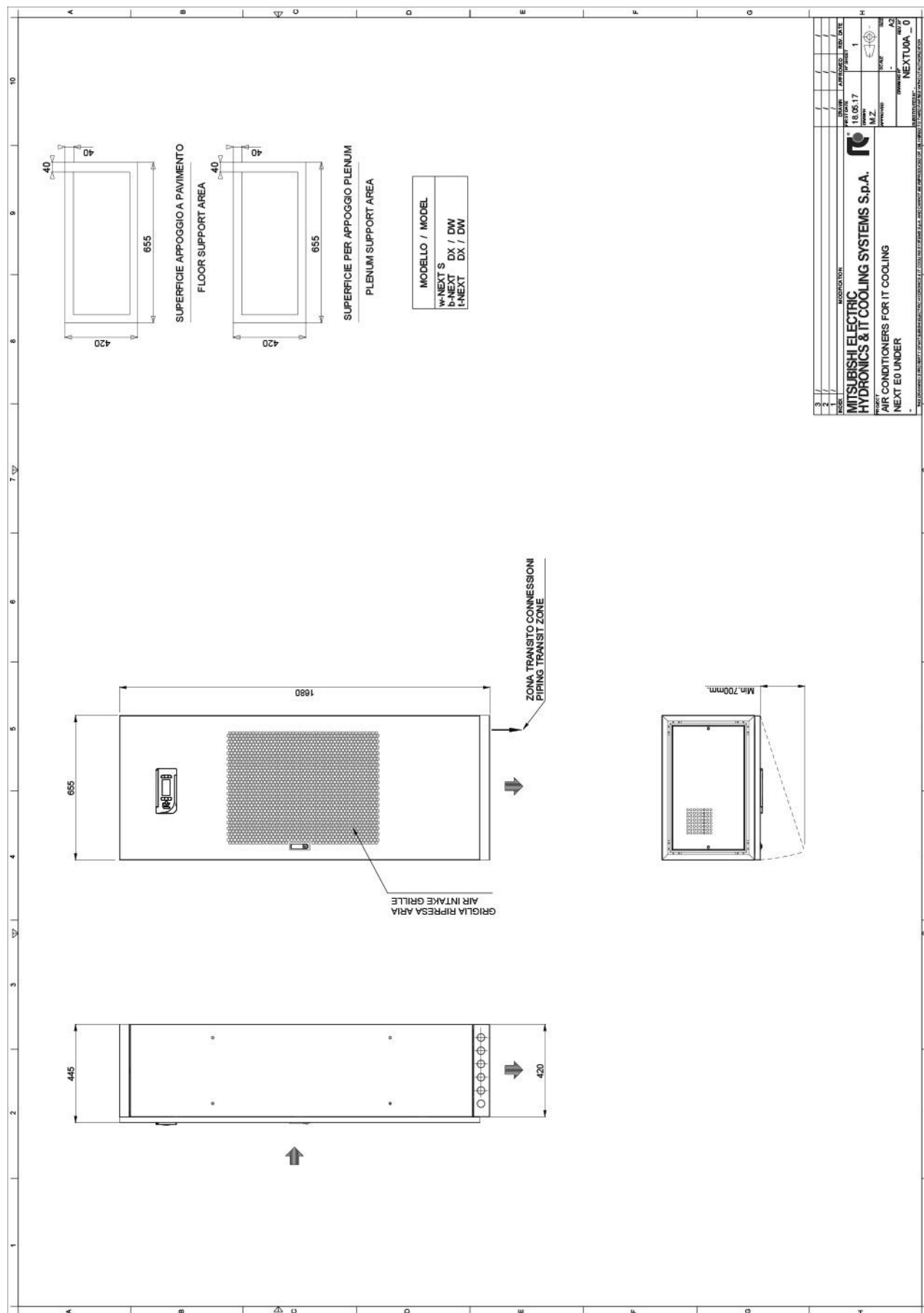

REV.	DESCRIPTION	DATE
1	18.05.17	

MITSUBISHI ELECTRIC HYDRONICS & IT COOLING SYSTEMS S.p.A.
 AIR CONDITIONERS FOR IT COOLING
 NEXT ED UNDER
 NEXTUOA_0



MACHINE DRAWINGS - Dimensions in mm - w-NEXT S Under E1

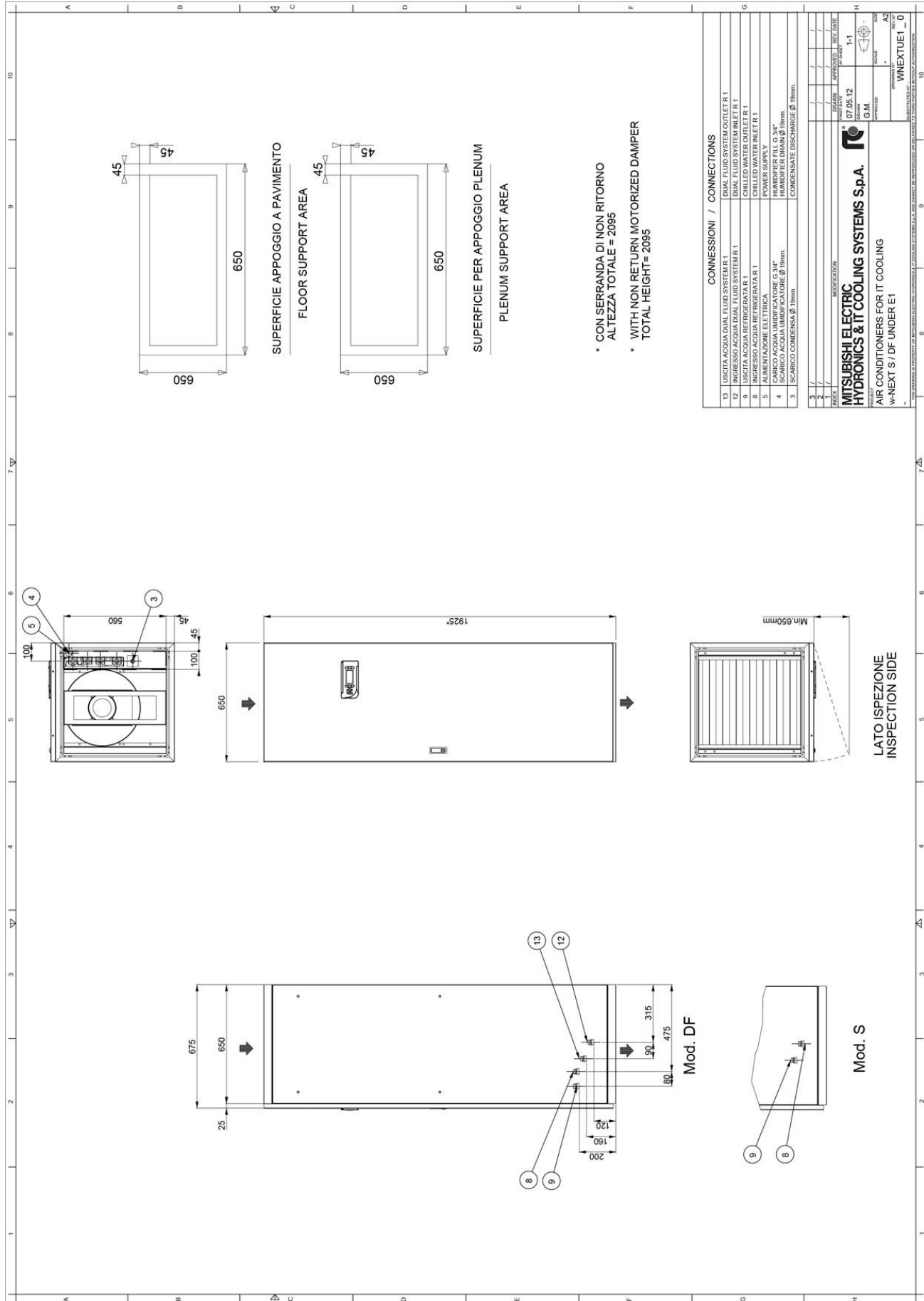

MACHINE DRAWINGS - Dimensions in mm - w-NEXT S Under E3

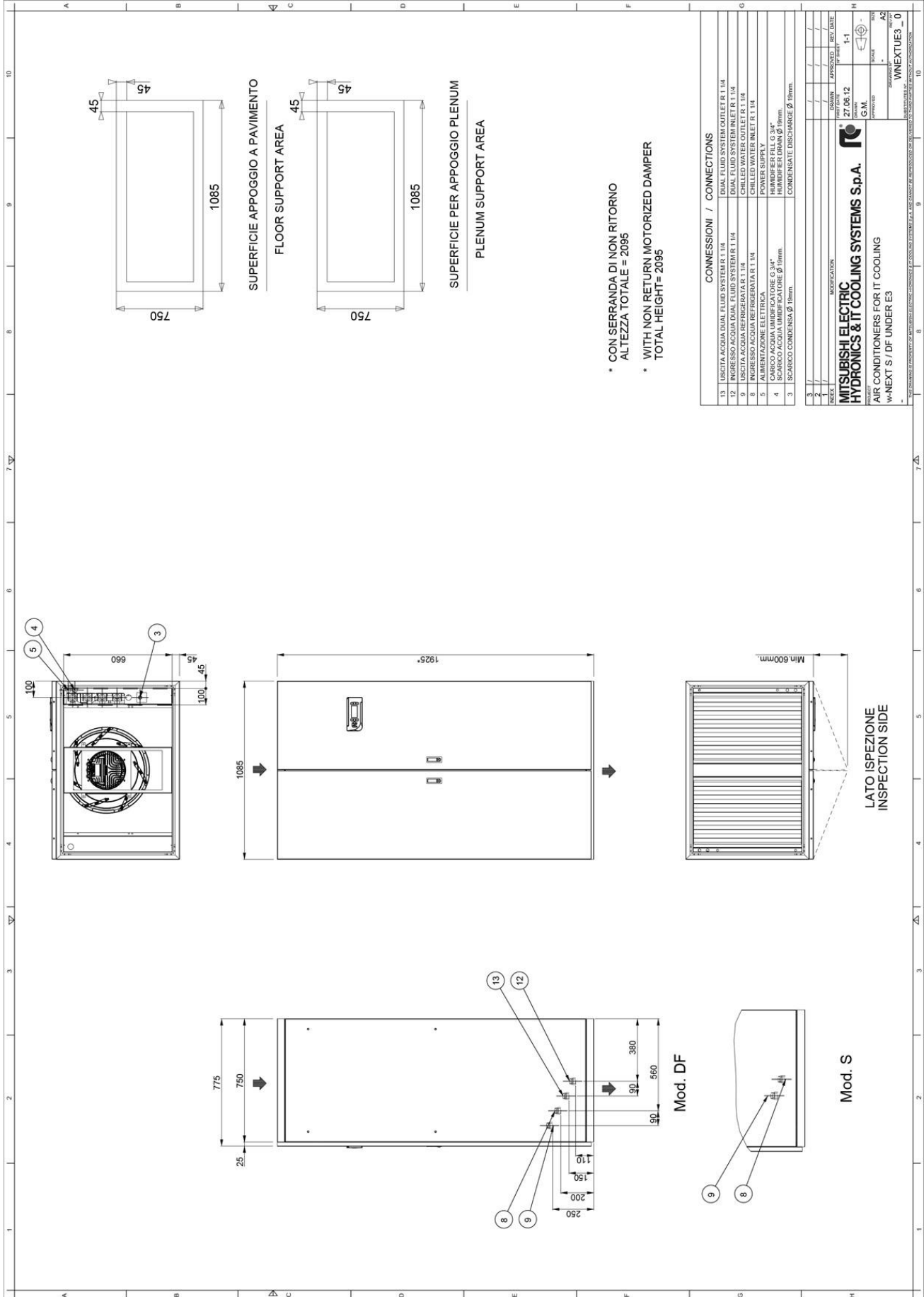

MACHINE DRAWINGS - Dimensions in mm - w-NEXT S Under E3P

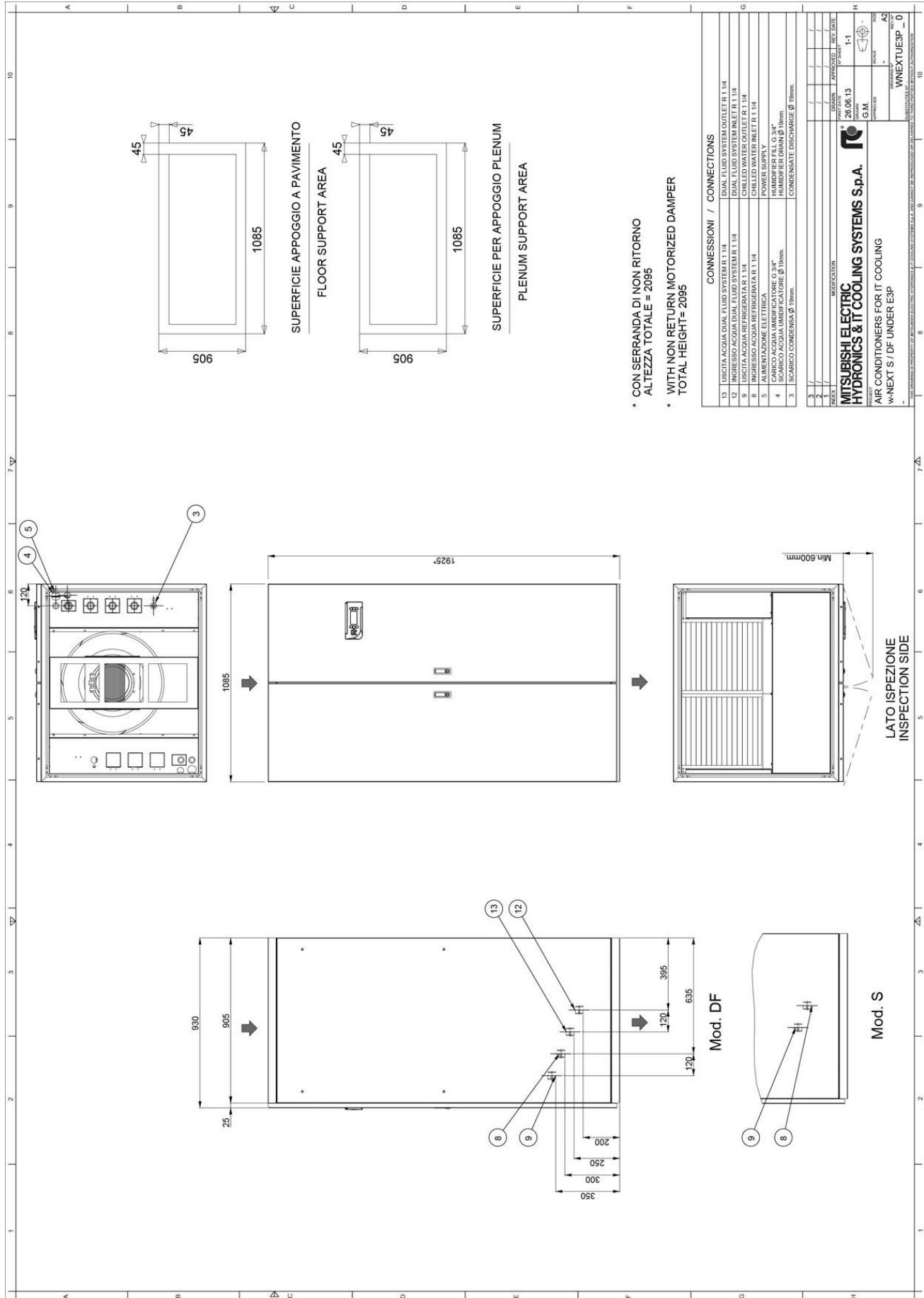

CONNESSIONI / CONNECTIONS	
13	USCITA ACQUA DUAL FLUID SYSTEM OUTLET R 1/4
12	INGRESSO ACQUA DUAL FLUID SYSTEM INLET R 1/4
11	INGRESSO ACQUA REFRIGERANTE R 1/4
8	INGRESSO ACQUA REFRIGERATA R 1/4
7	USCITA ACQUA REFRIGERATA R 1/4
5	ALIMENTAZIONE ELETTRICA / POWER SUPPLY
4	CARICO ACQUA UMIDIFICATORE G 3/4"
3	SCARICO ACQUA UMIDIFICATORE Ø 19mm
	CONDENSATE DISCHARGE Ø 19mm

REV.	DESCRIPTION	DATE	BY	CHK
1	INITIAL	26.06.13	G.M.	
2	MODIFIED			
3	REVISION			

MITSUBISHI ELECTRIC HYDRONICS & IT COOLING SYSTEMS S.p.A.
 AIR CONDITIONERS FOR IT COOLING
 w-NEXT S / DF UNDER E3P

SCALE: 1-1
 WNEXTUE3P_0



MACHINE DRAWINGS - Dimensions in mm - w-NEXT S Under E4

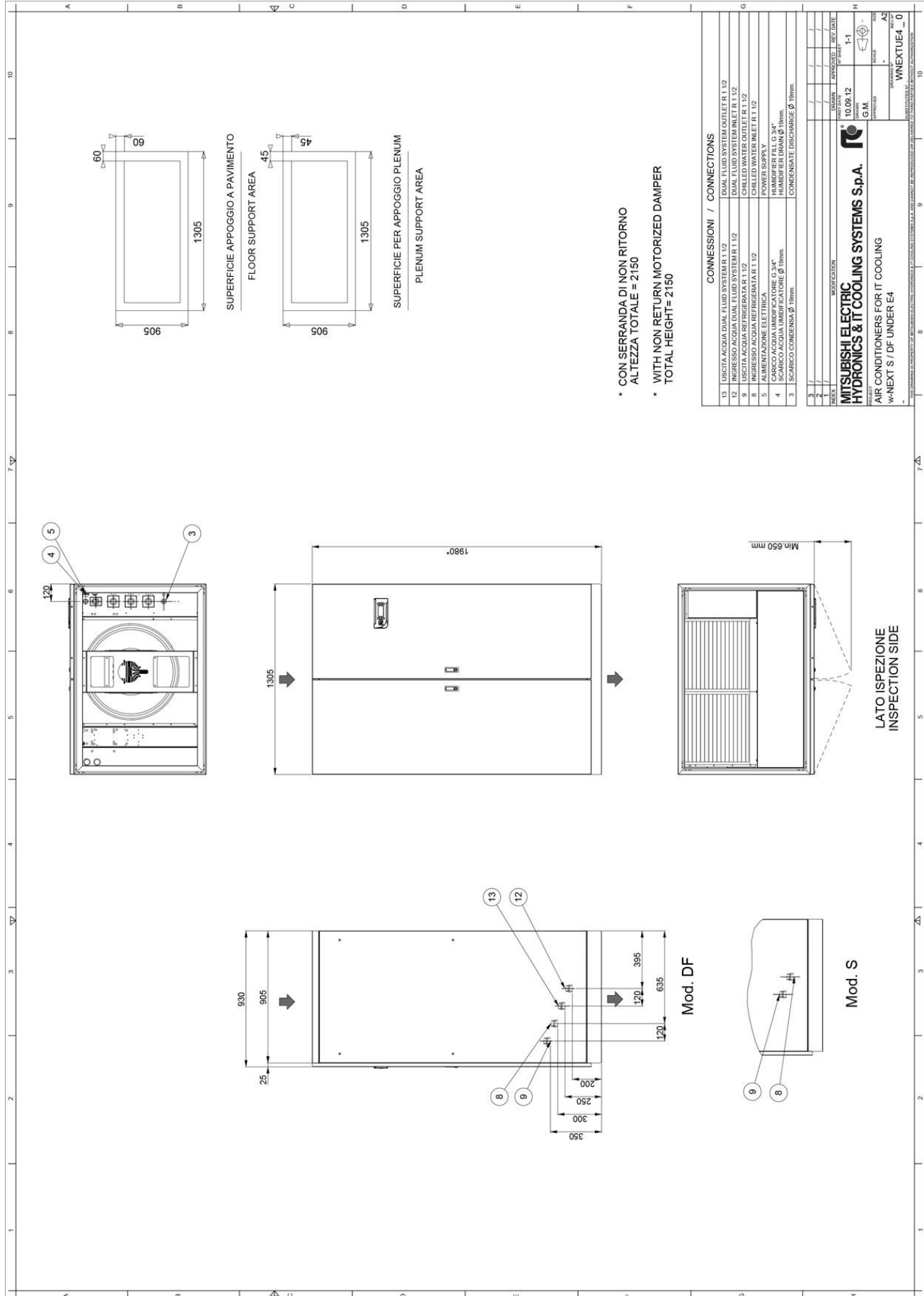

MACHINE DRAWINGS - Dimensions in mm - w-NEXT S Under E5

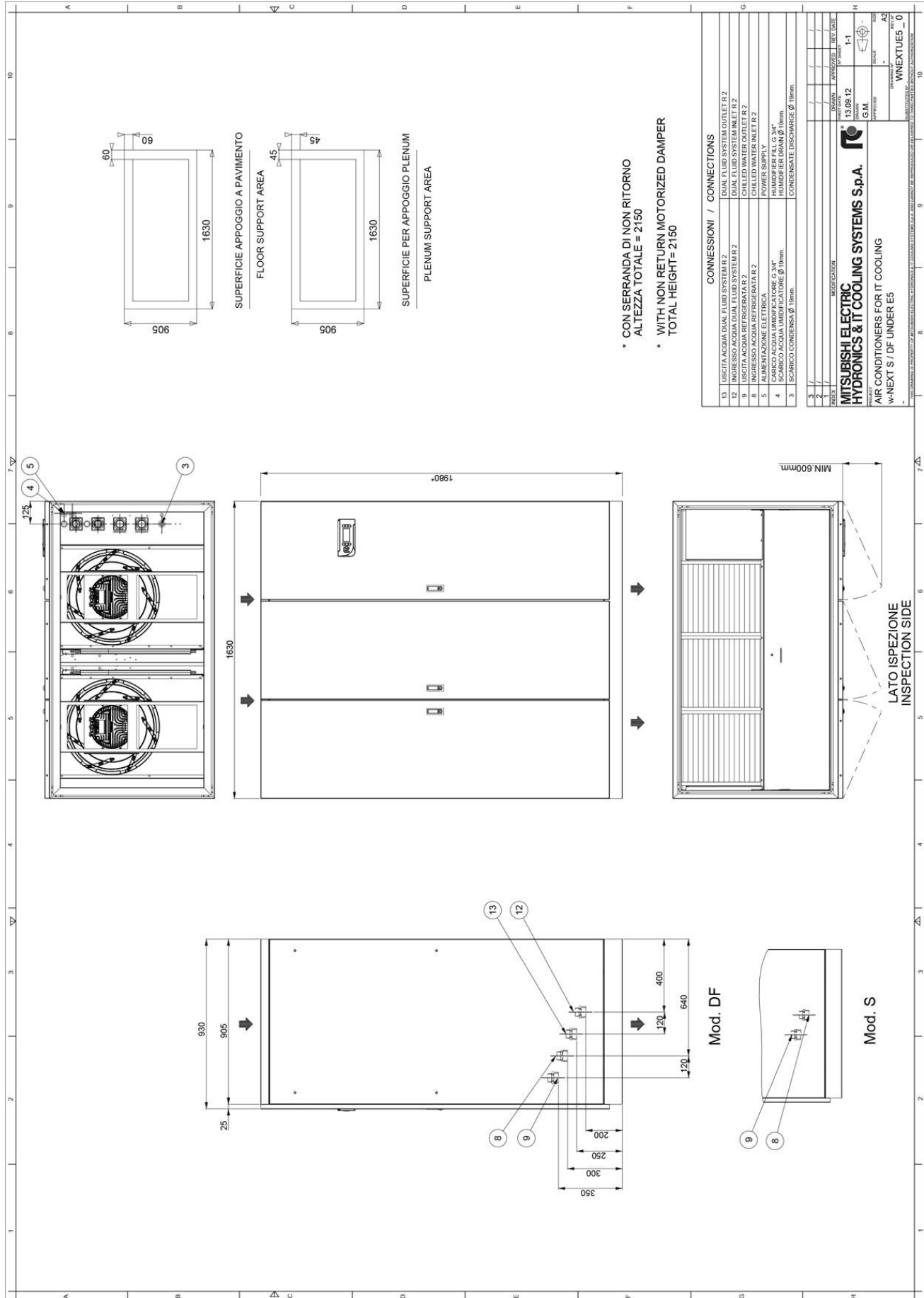

MACHINE DRAWINGS - Dimensions in mm - w-NEXT S Under E6

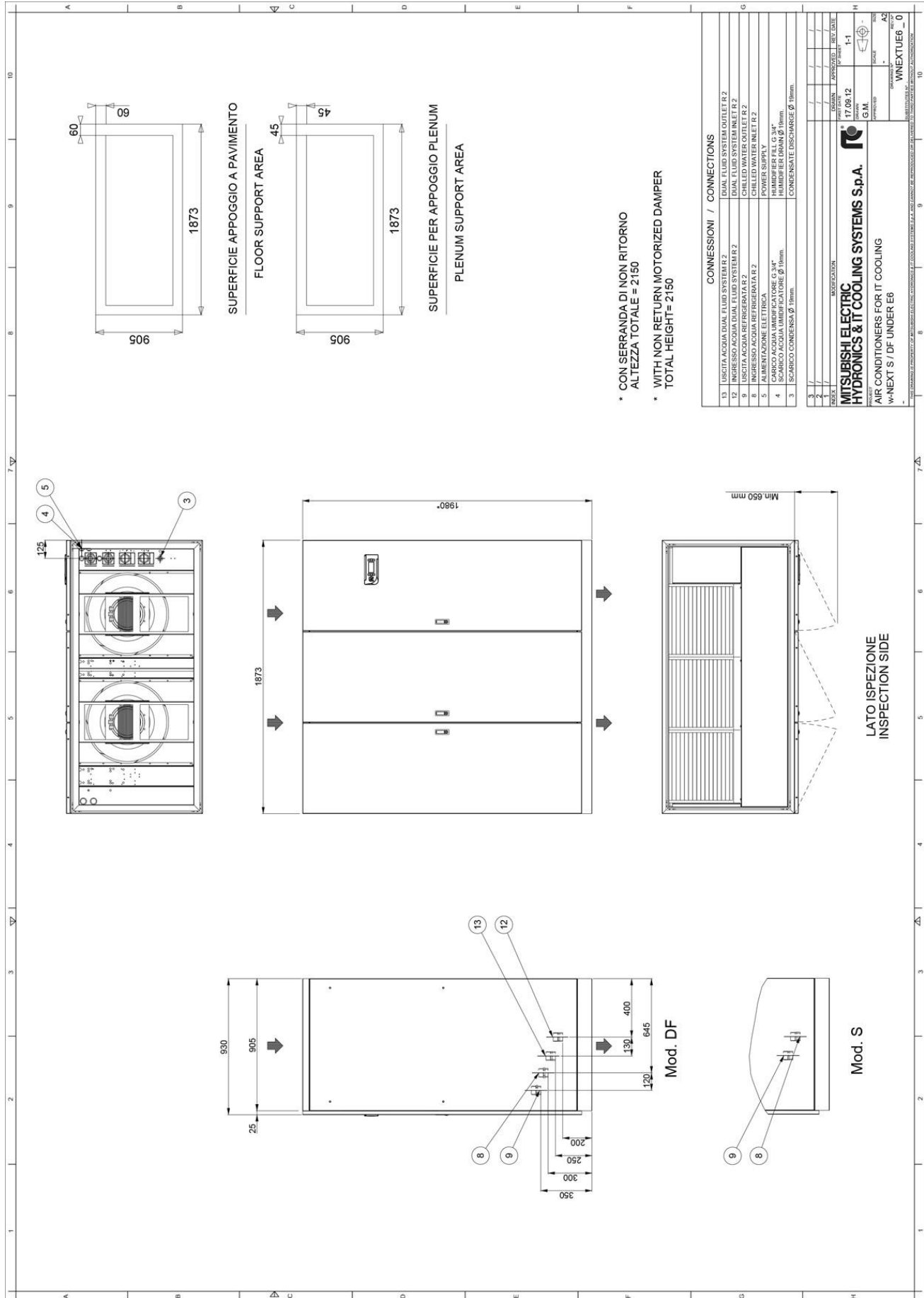

MACHINE DRAWINGS - Dimensions in mm - w-NEXT S Under E7

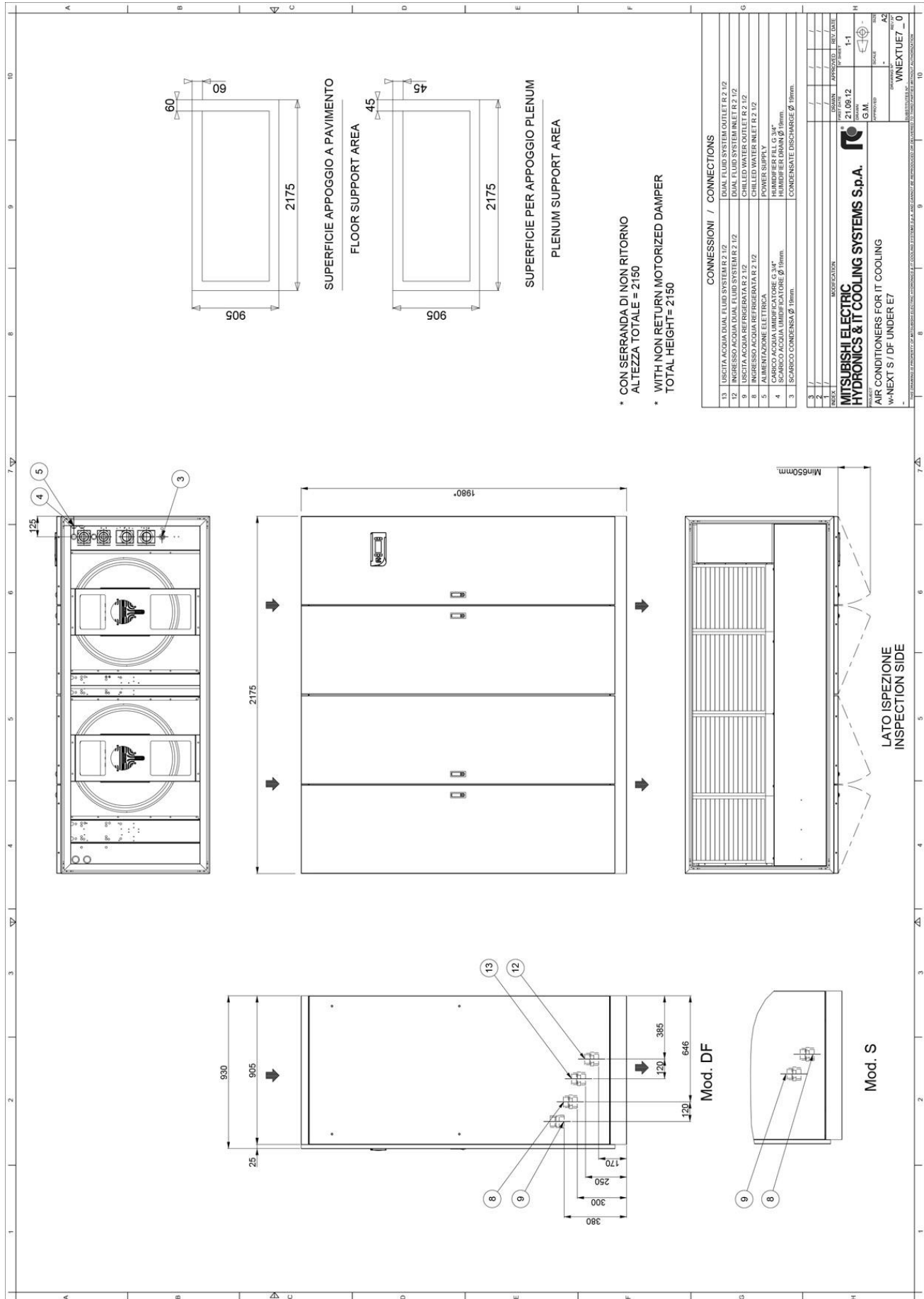

MACHINE DRAWINGS - Dimensions in mm - w-NEXT S Under E8

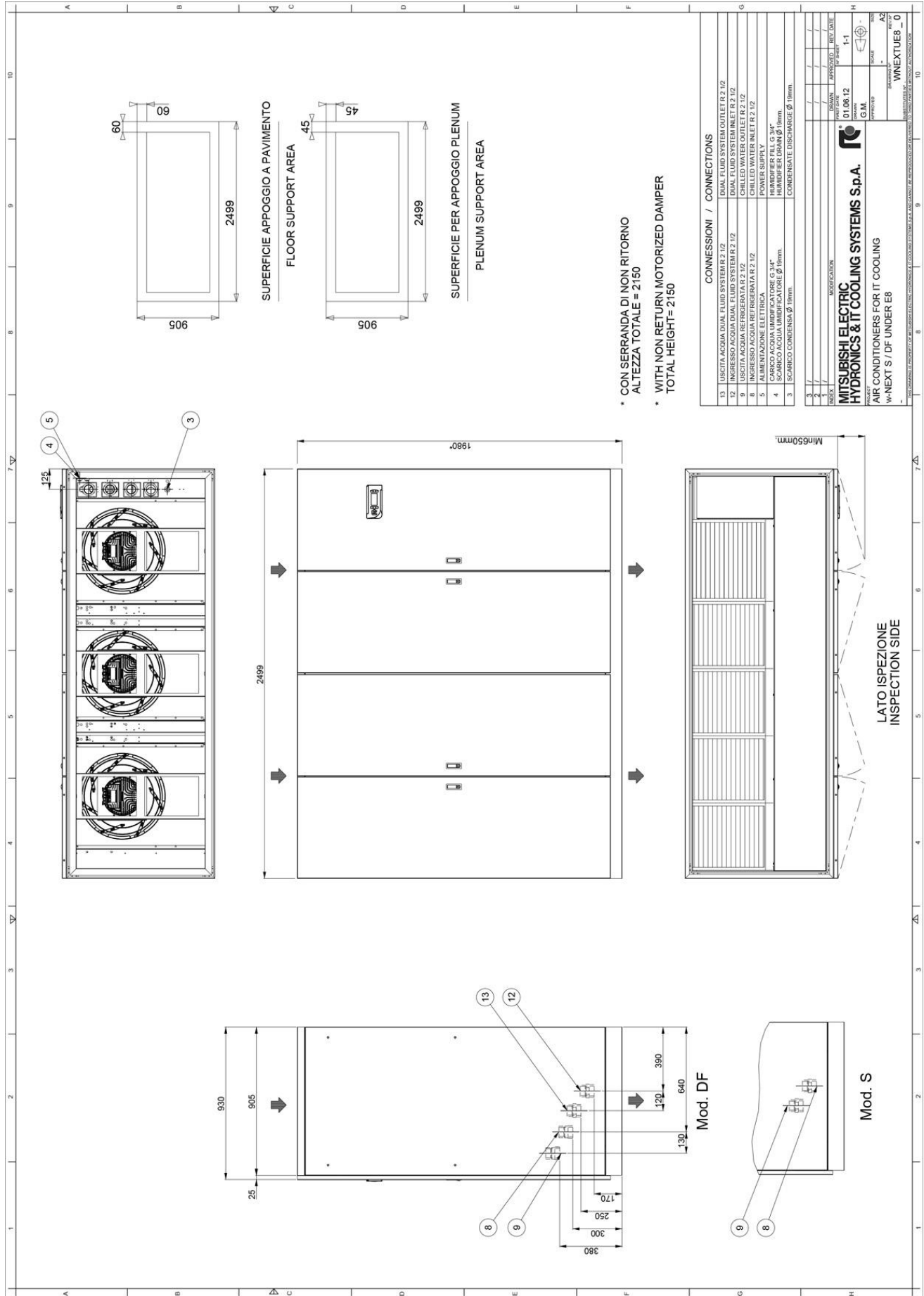

MACHINE DRAWINGS - Dimensions in mm - w-NEXT S Under E9

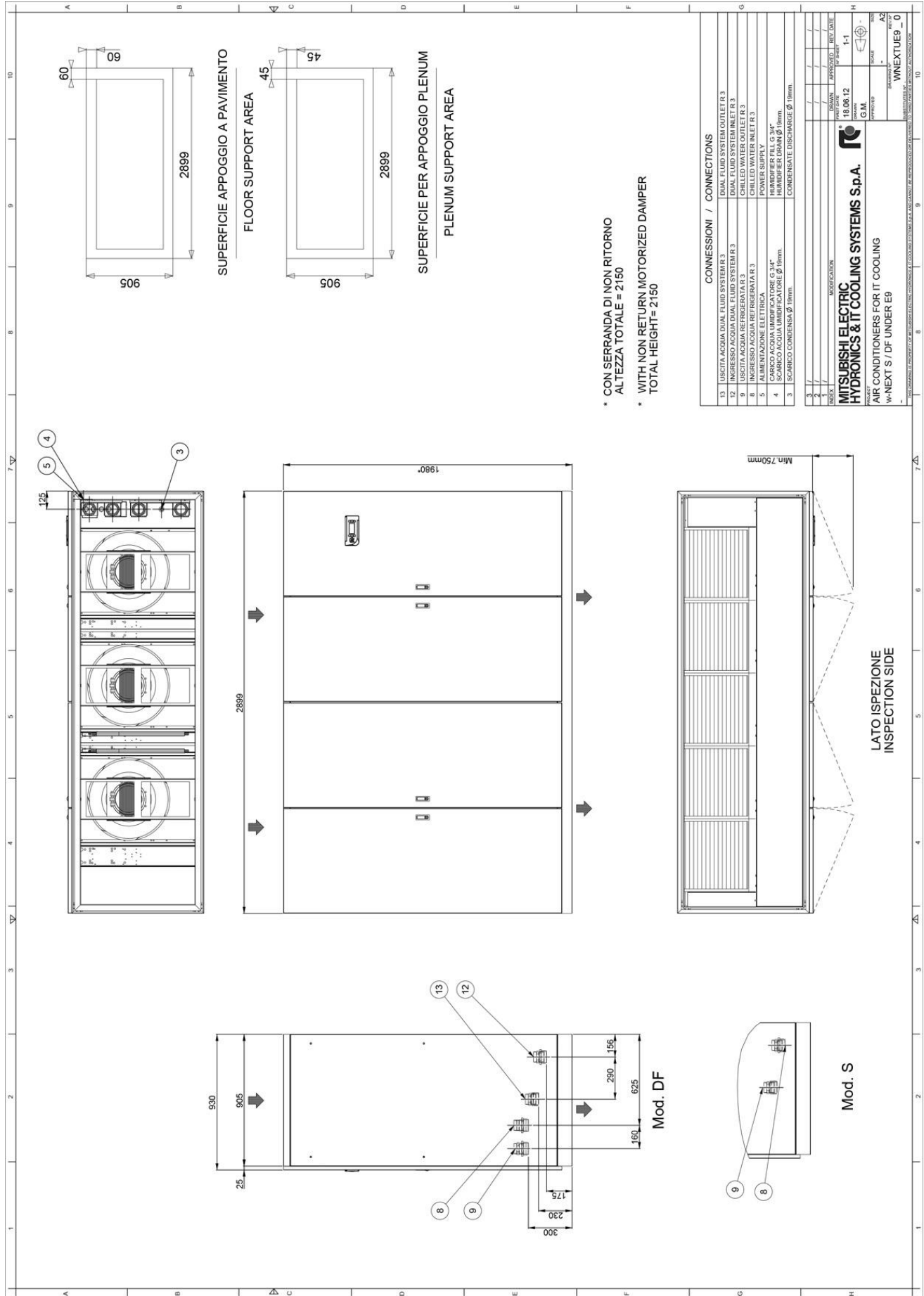

MACHINE DRAWINGS - Dimensions in mm - w-NEXT S Over E0

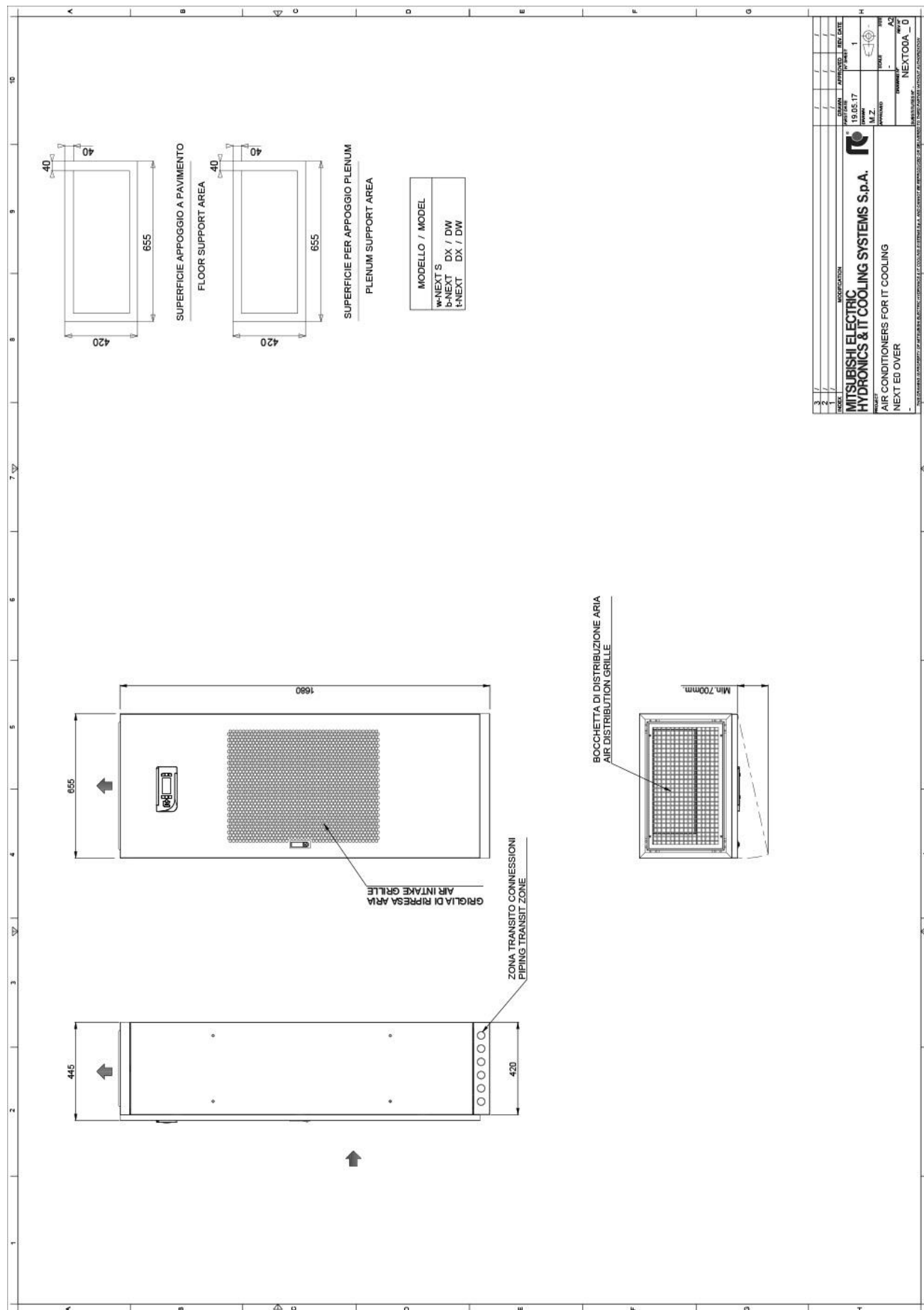

REVISIONI	DATA	DESCRIZIONE	PROGETTISTA	VERIFICATORE
1	19.05.17			
2				
3				

MITSUBISHI ELECTRIC HYDRONICS & IT COOLING SYSTEMS S.p.A.
 AIR CONDITIONERS FOR IT COOLING
 NEXT ED OVER
 NEXT00A_0



MACHINE DRAWINGS - Dimensions in mm - w-NEXT S Over E1

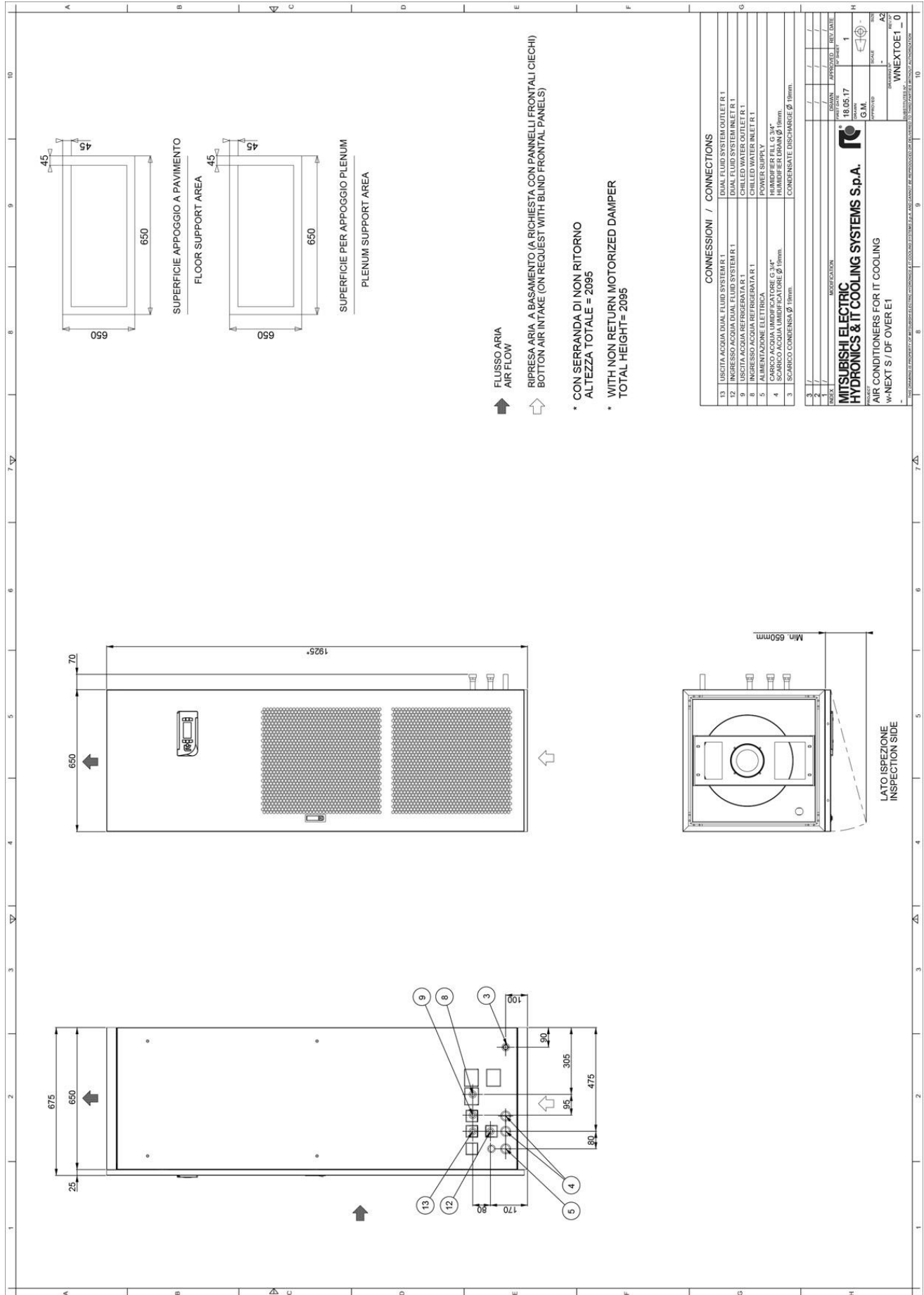

MACHINE DRAWINGS - Dimensions in mm - w-NEXT S Over E2

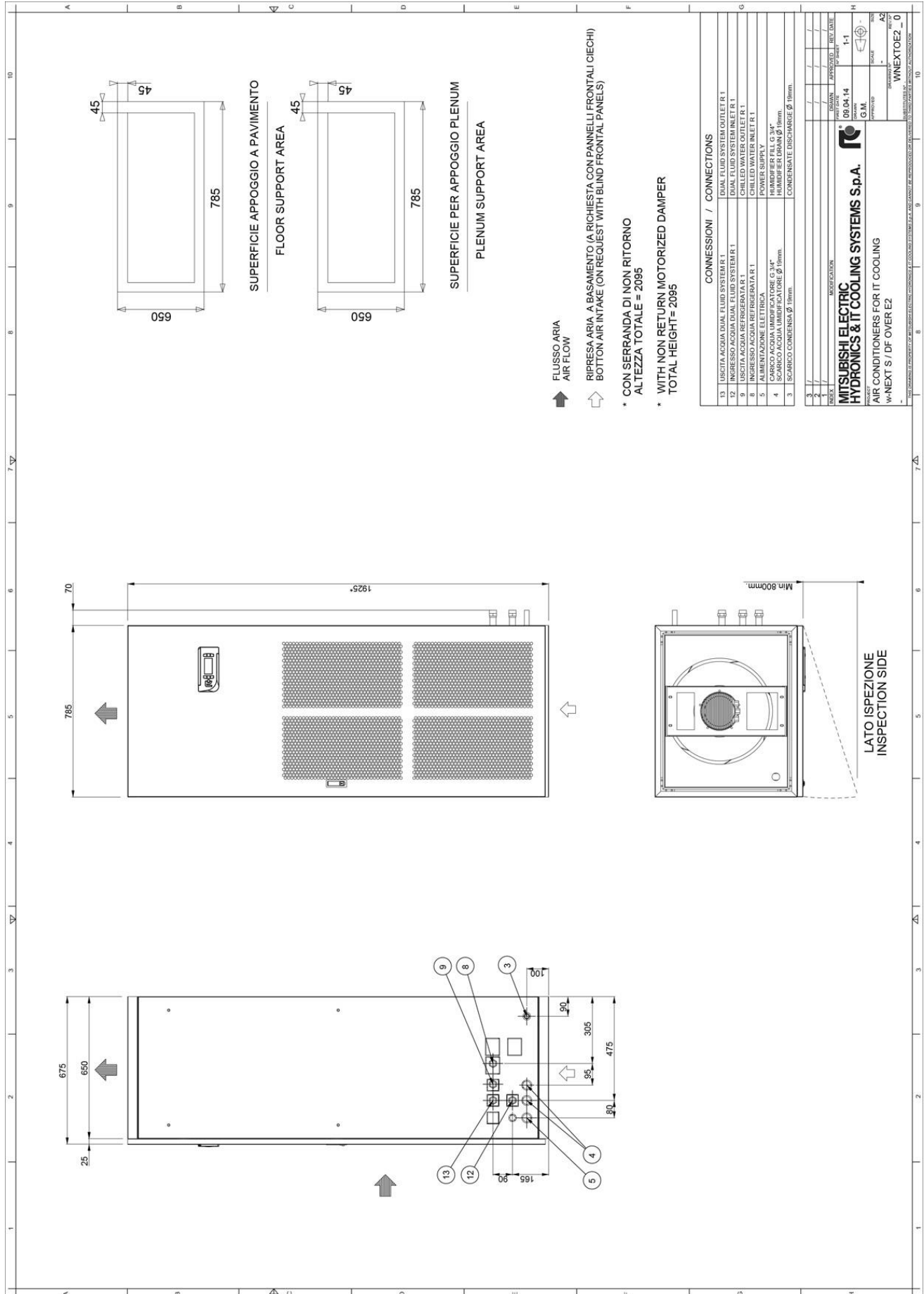

MACHINE DRAWINGS - Dimensions in mm - w-NEXT S Over E3

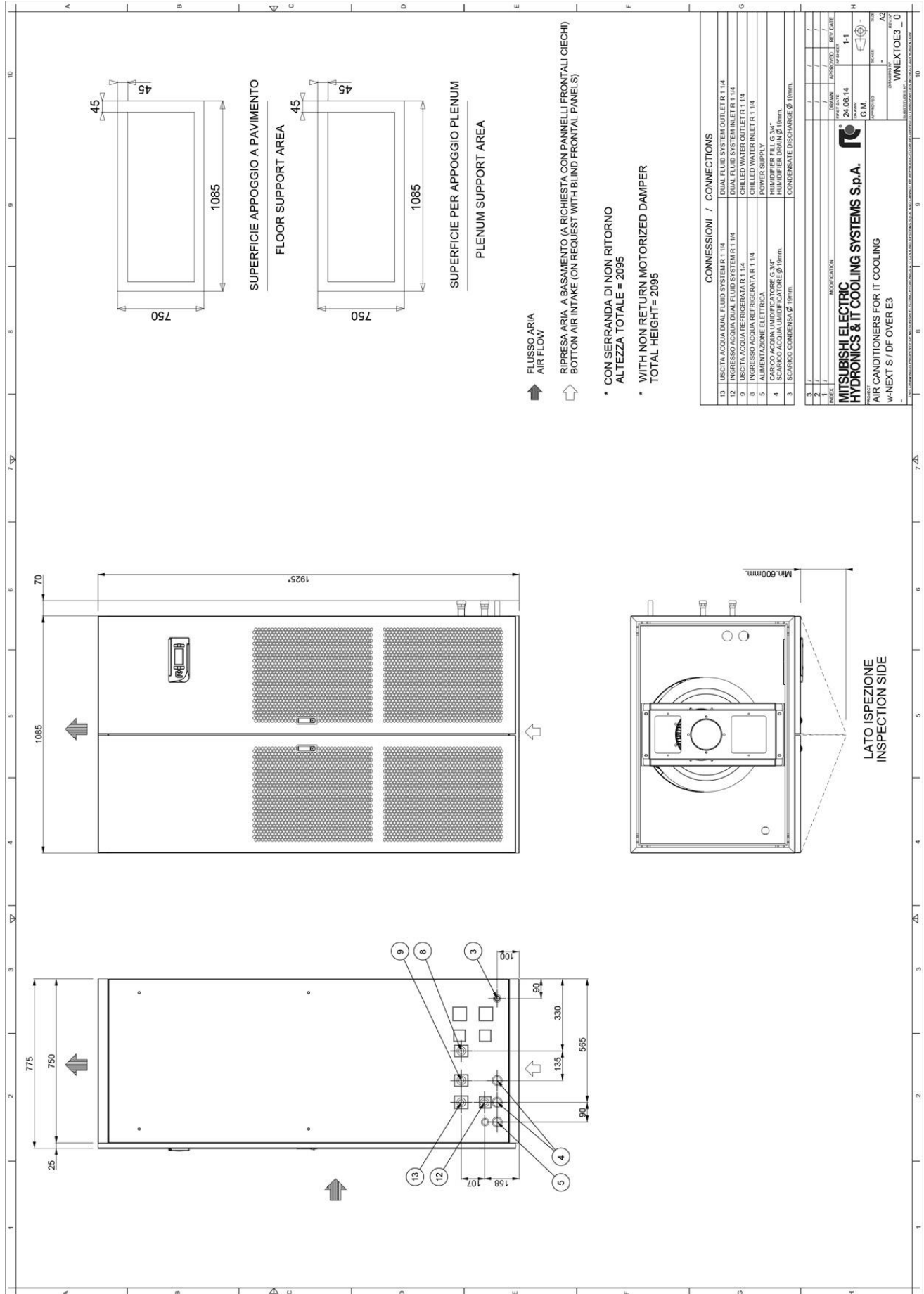

MACHINE DRAWINGS - Dimensions in mm - w-NEXT S Over E3P

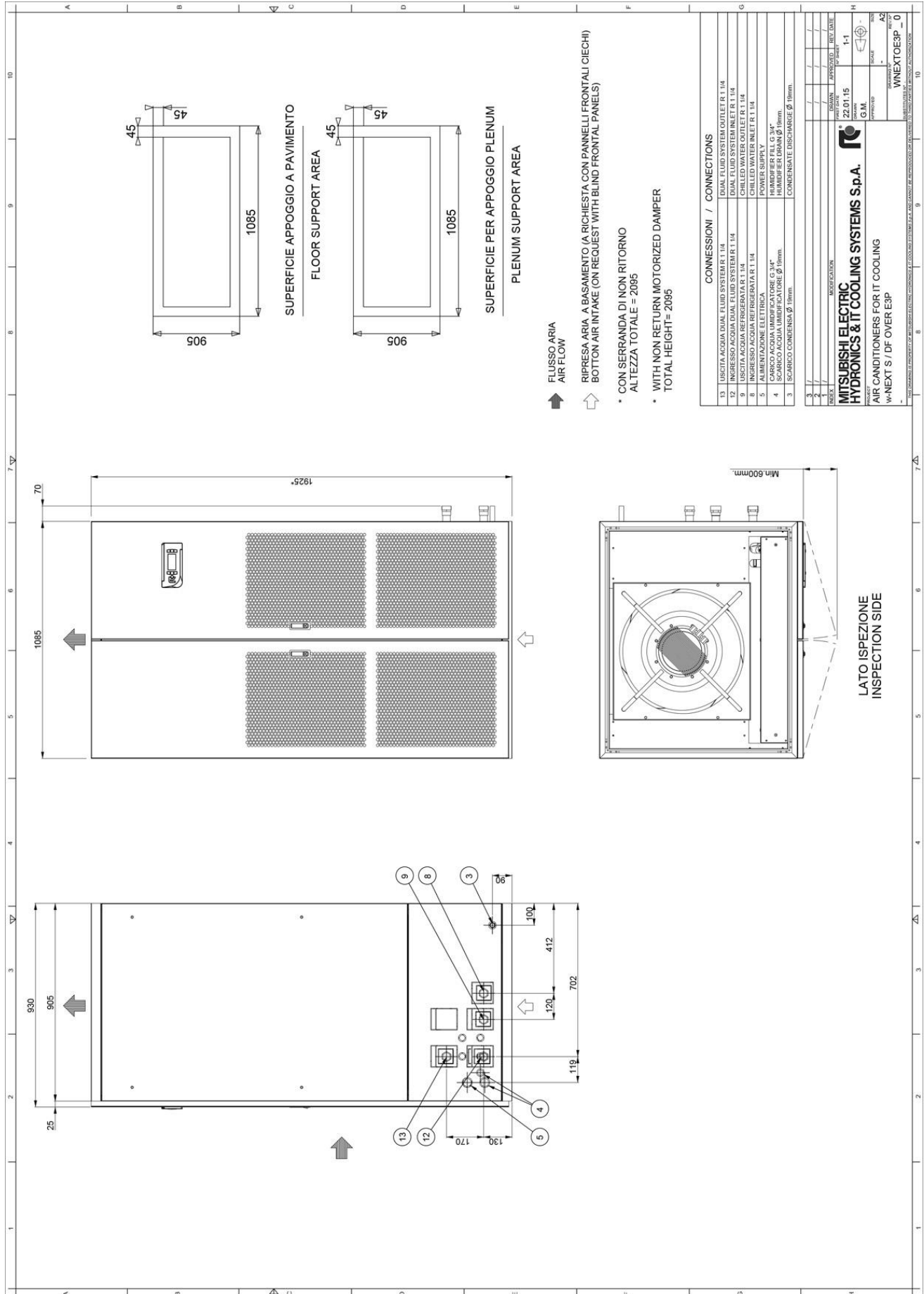

MACHINE DRAWINGS - Dimensions in mm - w-NEXT S Over E4

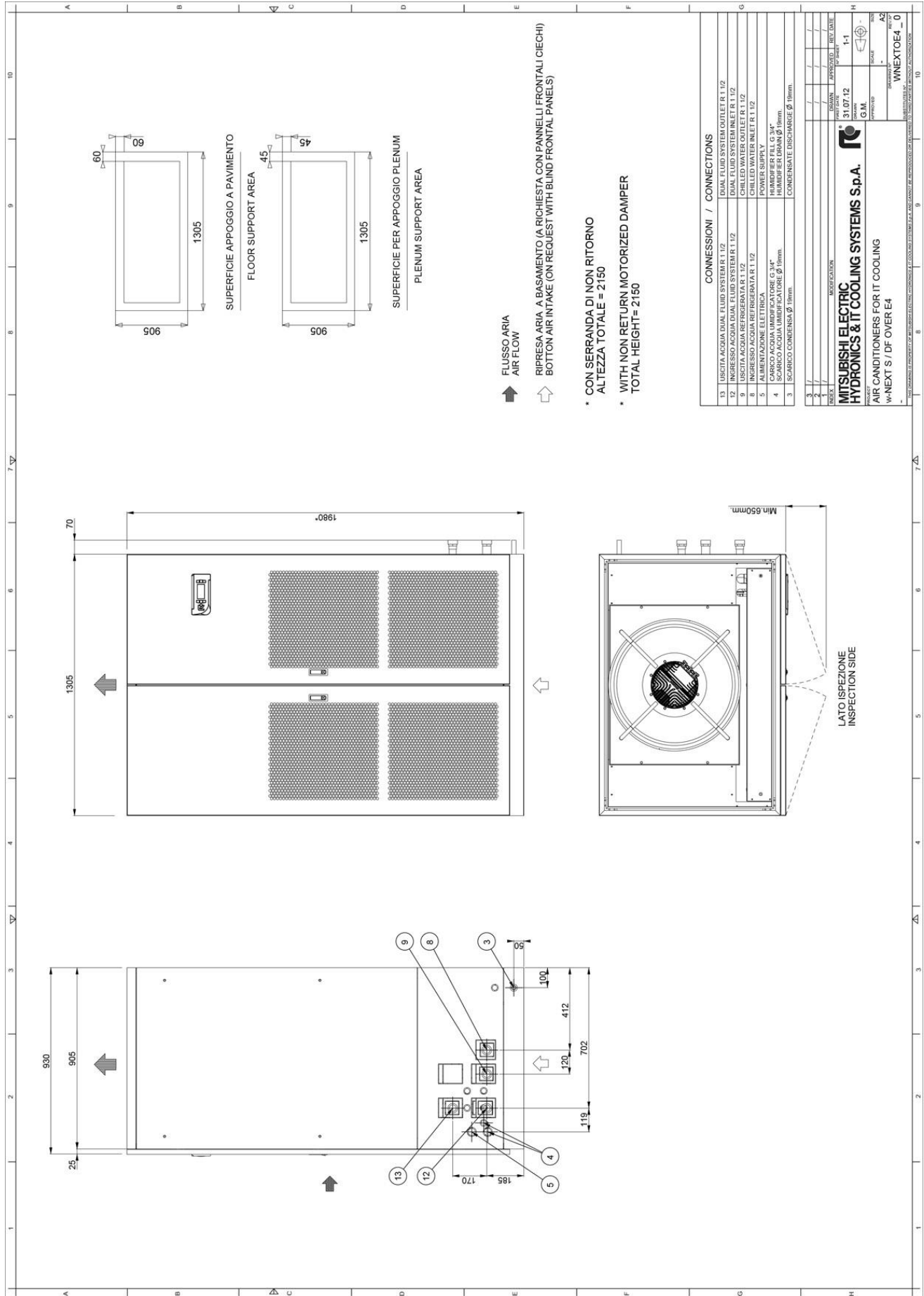

MACHINE DRAWINGS - Dimensions in mm - w-NEXT S Over E5

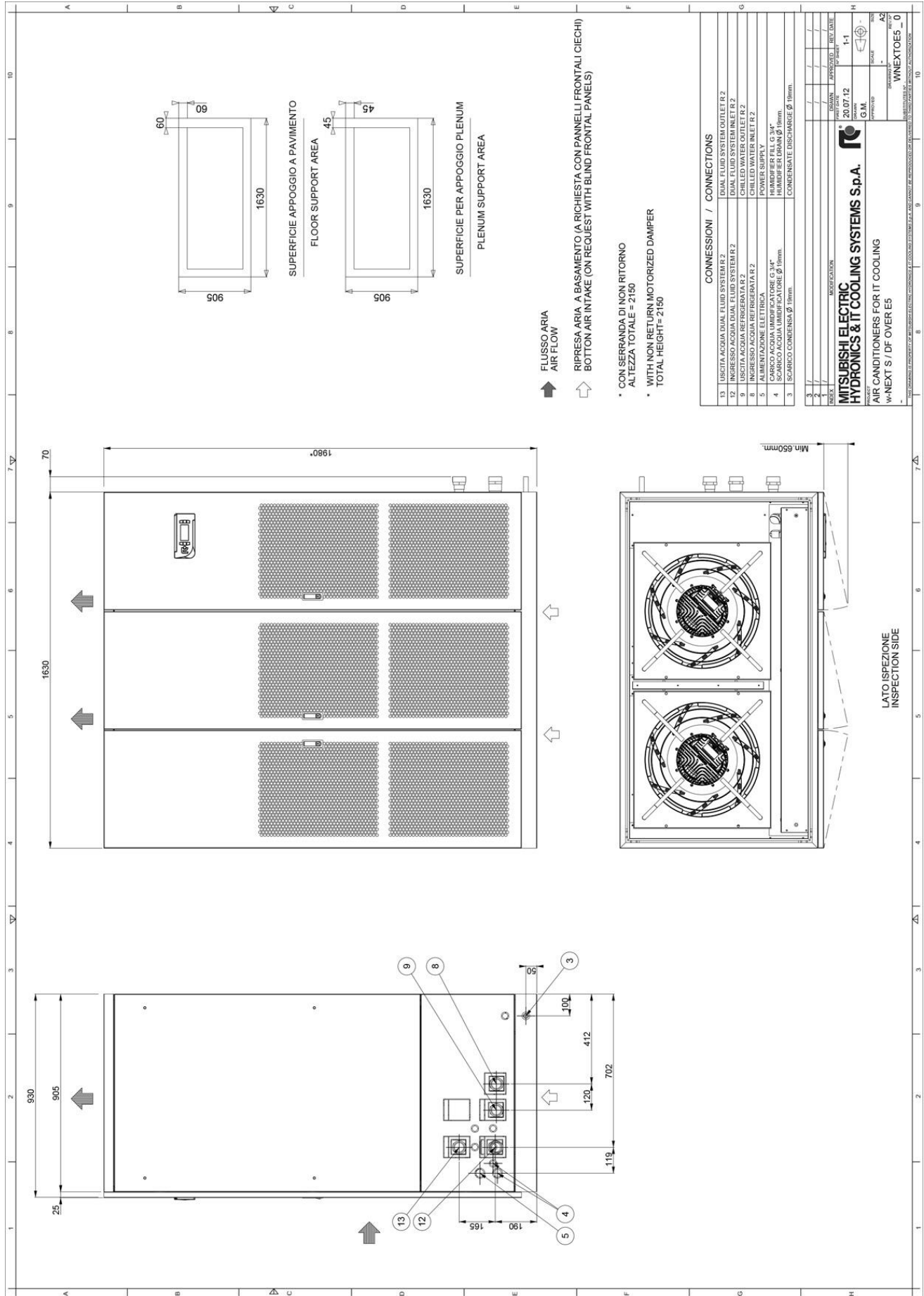

MACHINE DRAWINGS - Dimensions in mm - w-NEXT S Over E6

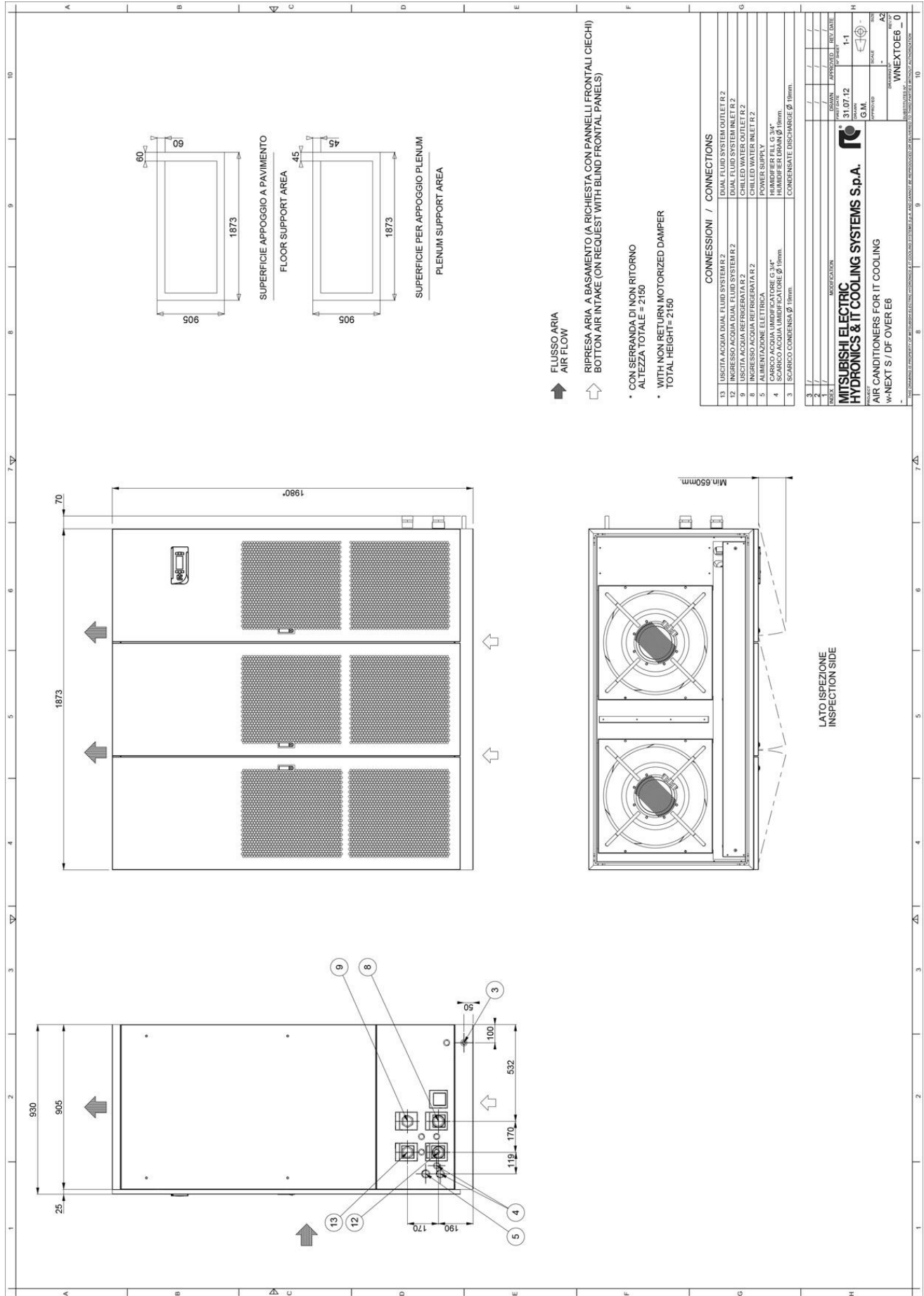

MACHINE DRAWINGS - Dimensions in mm - w-NEXT S Over E7

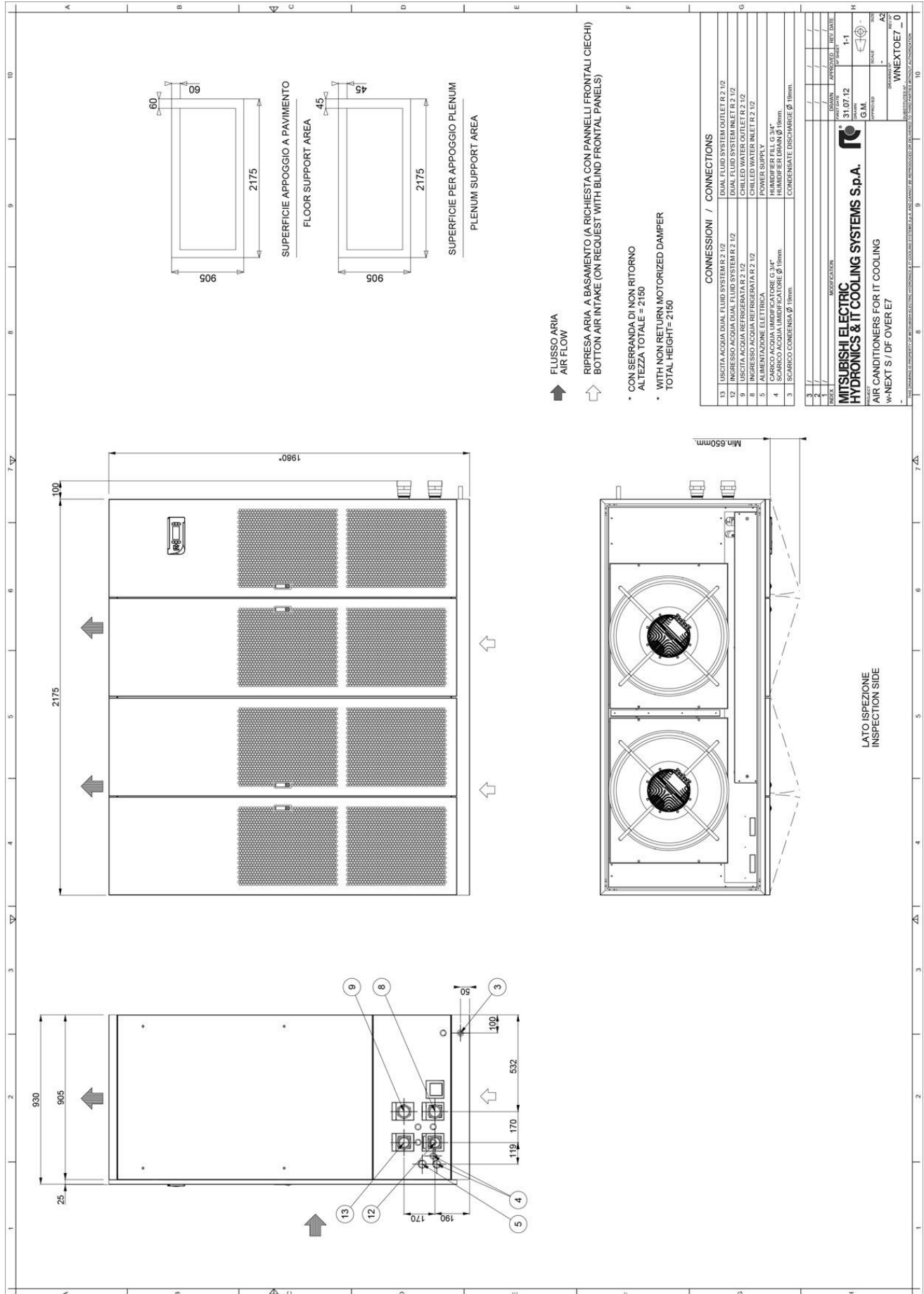

MACHINE DRAWINGS - Dimensions in mm - w-NEXT S Over E8

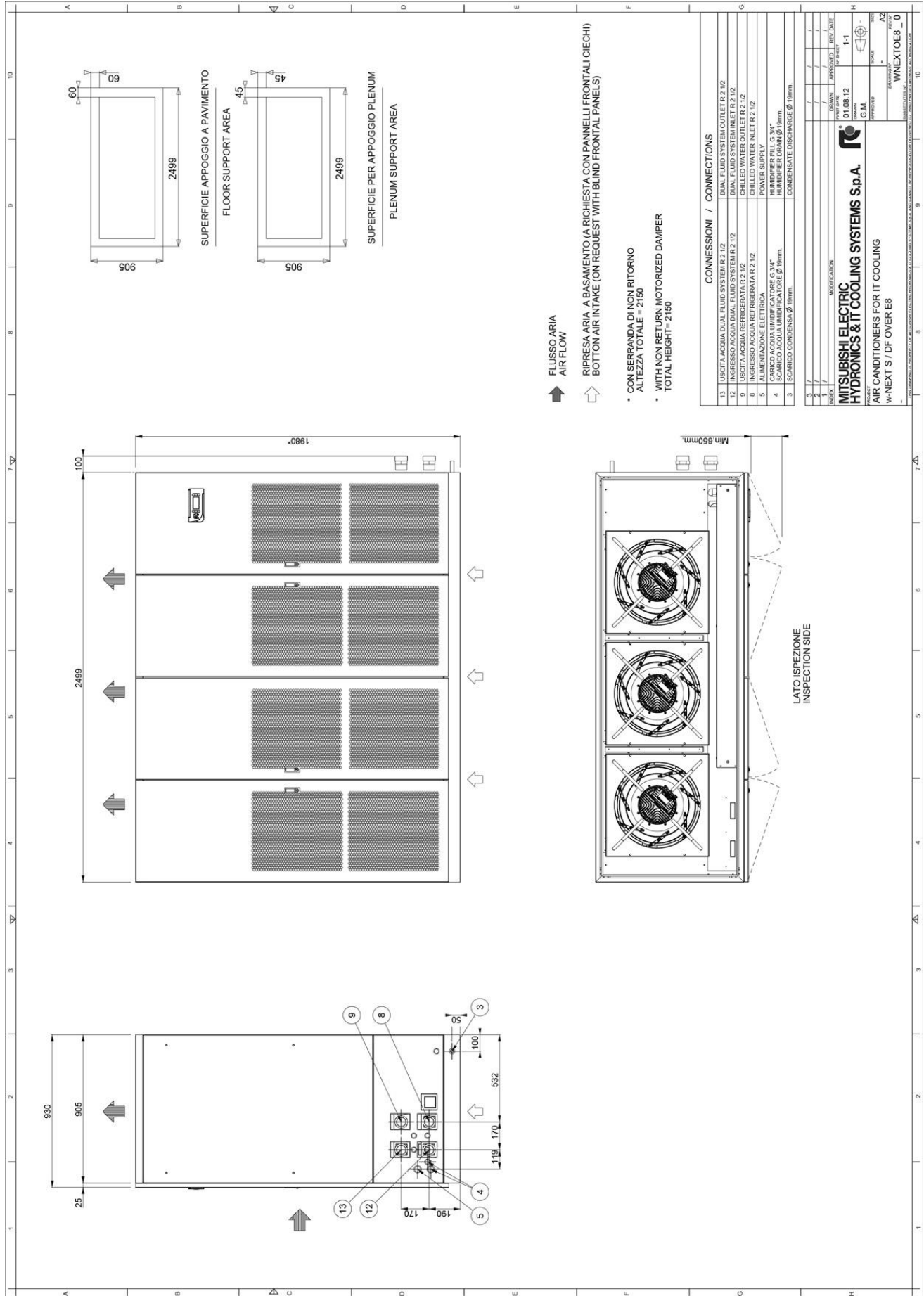

MACHINE DRAWINGS - Dimensions in mm - w-NEXT S Over E9

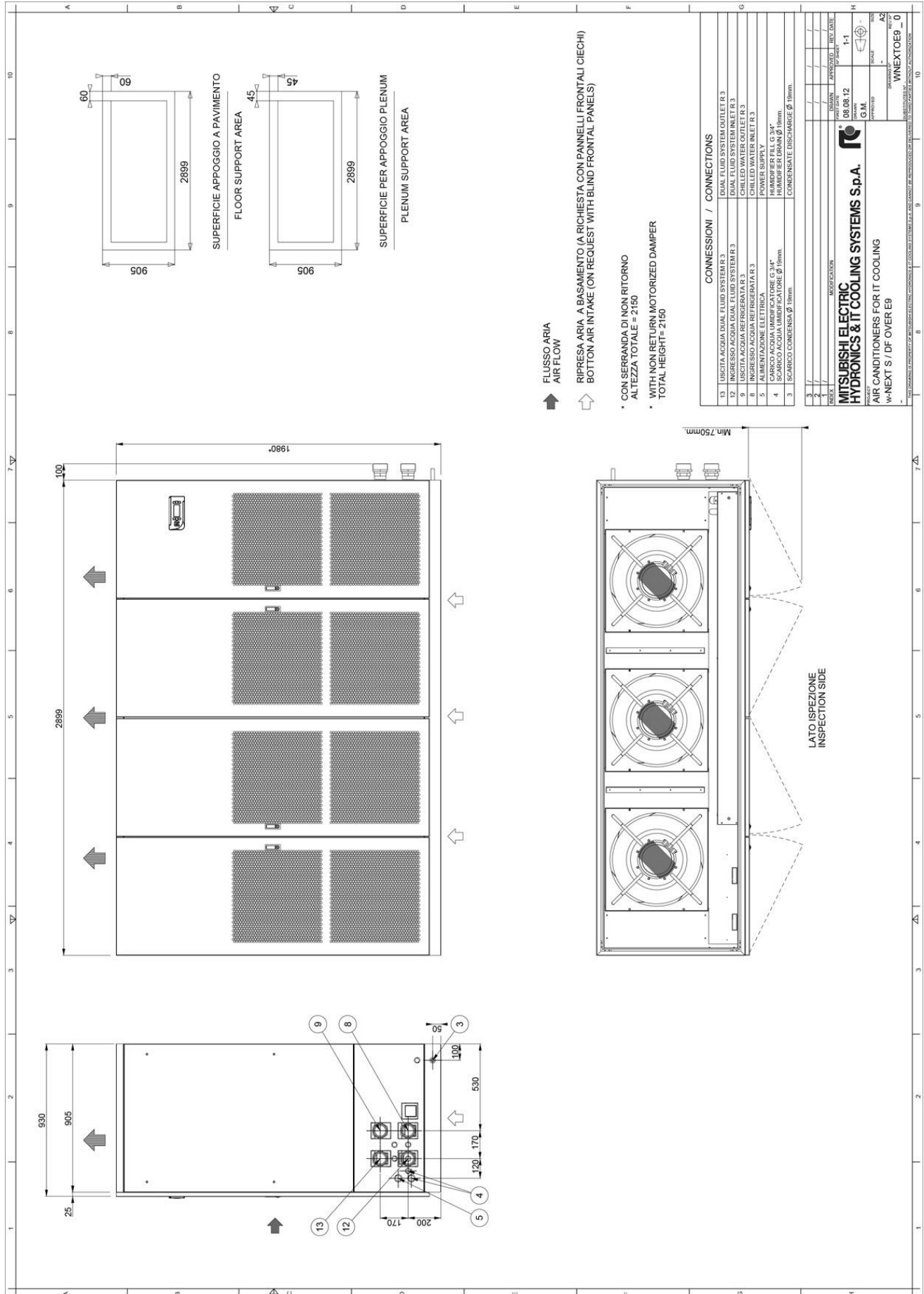

HOLE IN THE RAISED FLOOR FOR DOWNFLOW VERSION

HOLE IN THE RAISED FLOOR WITHOUT FLOOR STAND

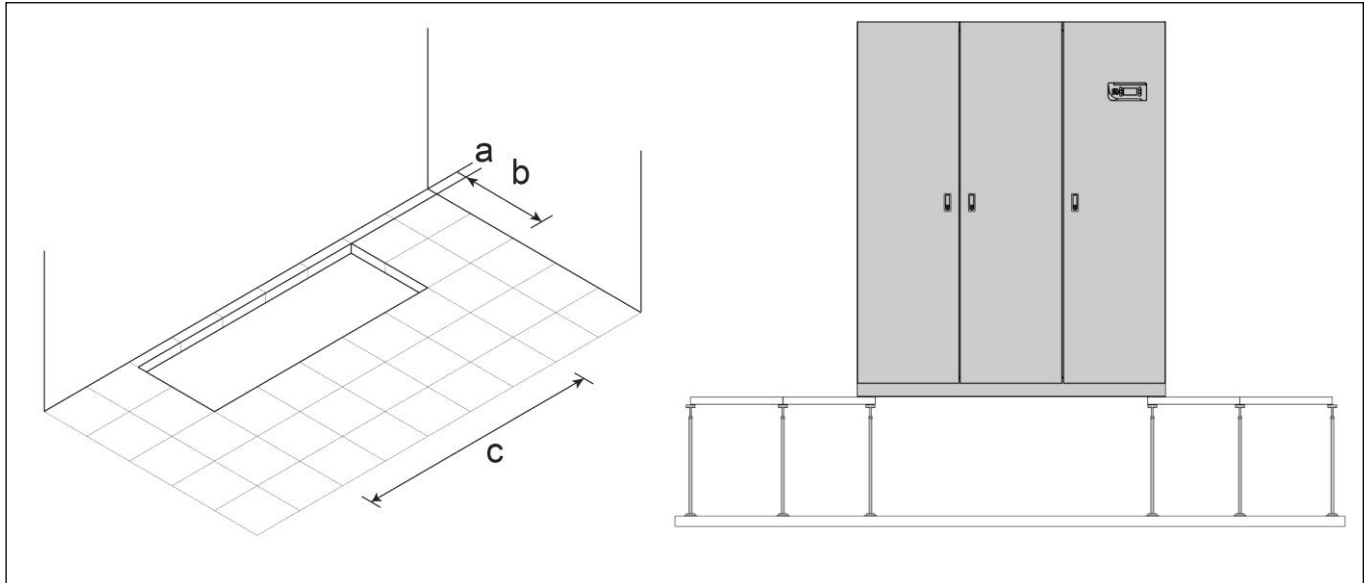

Foresee a hole in the floor with the following dimensions:

		E0	E1	E2	E3	E3P	E4	E5	E6	E7	E8	E9	E10
a	mm	90	95	95	95	95	110	110	110	110	110	110	110
b	mm	340	560	560	660	815	785	785	785	785	785	785	785
c	mm	585	560	695	995	995	1185	1510	1755	2055	2380	2780	3390

HOLE IN THE RAISED FLOOR WITH FLOOR STAND (OPTION)

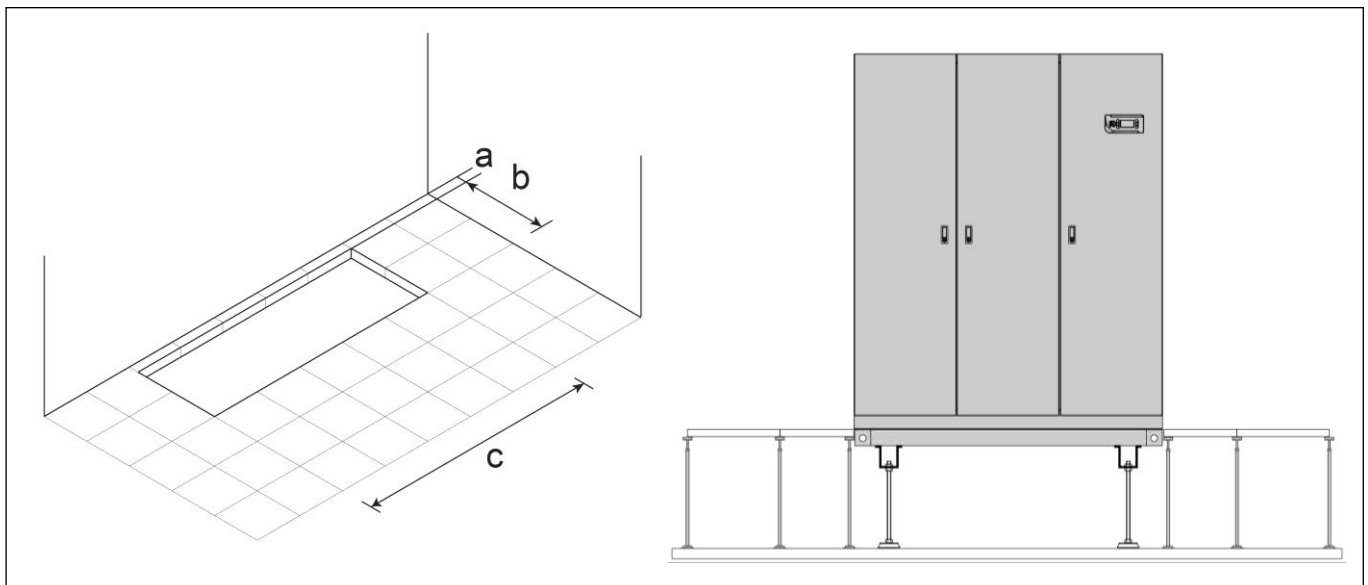

Foresee a hole in the floor with the following dimensions:

		E0	E1	E2	E3	E3P	E4	E5	E6	E7	E8	E9	E10
a	mm	50	50	50	50	50	50	50	50	50	50	50	50
b	mm	440	670	670	770	925	925	925	925	925	925	925	925
c	mm	675	670	805	1105	1105	1325	1650	1895	2195	2520	2920	3530

EXAMPLE FOR MACHINES NOISE EMISSION CALCULATION

w-NEXT S UNDER WITH DUCT ON AIR INTAKE

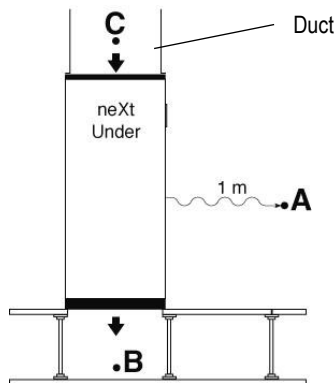

Lp A = Front side Under catalogue value

Lp B = Air delivery Under catalogue value

Lp C = Air intake Under catalogue value

The points B and C do not influence the point A

w-NEXT S UNDER WITH PLENUM ON AIR DELIVERY

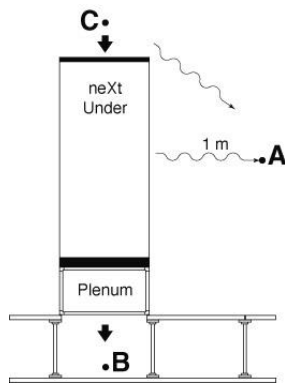

Lp A = Front side Under catalogue value

Lp B = Air delivery Under catalogue value – plenum noise reduction

Lp C = Air intake Under catalogue value

$$Lp A+C = 10 \log_{10} \left(10^{\frac{LpA}{10}} + 10^{\frac{LpC}{10}} \right)$$

The point B do not influence the point A

w-NEXT S UNDER WITH PLENUM ON AIR INTAKE

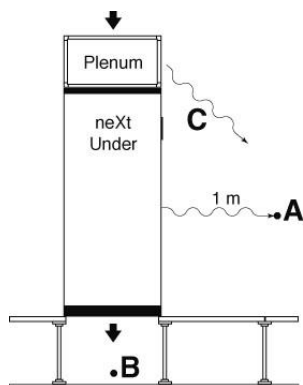

Lp A = Front side Under catalogue value

Lp B = Air delivery Under catalogue value

Lp C = Air intake Under catalogue value – plenum noise reduction

$$Lp A+C = 10 \log_{10} \left(10^{\frac{LpA}{10}} + 10^{\frac{LpC}{10}} \right)$$

The point B do not influence the point A

w-NEXT S OVER WITH DUCT

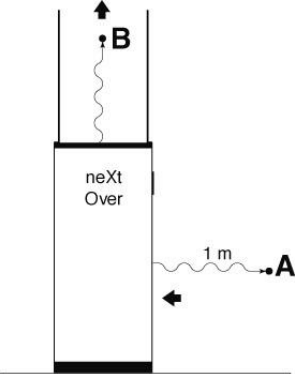

Lp A = Air intake Over catalogue value

Lp B = Air delivery Over catalogue value

The point B do not influence the point A

EXAMPLE FOR MACHINES NOISE EMISSION CALCULATION

w-NEXT S OVER WITH PLENUM ON AIR DELIVERY

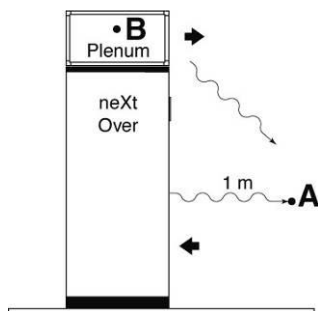

Lp A = Air intake Over catalogue value

Lp B = Air delivery Over catalogue value – plenum noise reduction

$$L_p A+B = 10 \log_{10} \left(10^{\frac{L_p A}{10}} + 10^{\frac{L_p C}{10}} \right)$$

w-NEXT S OVER WITH DUCT AND PLENUM ON AIR DELIVERY

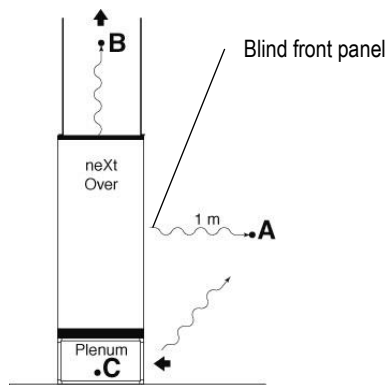

Lp A = Radiated Over catalogue value

Lp B = Air delivery Over catalogue value

Lp C = Lp A + 6dB(A) – plenum noise reduction

$$L_p A+C = 10 \log_{10} \left(10^{\frac{L_p A}{10}} + 10^{\frac{L_p C}{10}} \right)$$

The point B do not influence the point A+C

w-NEXT S OVER WITH DUCT AND PLENUM ON AIR DELIVERY

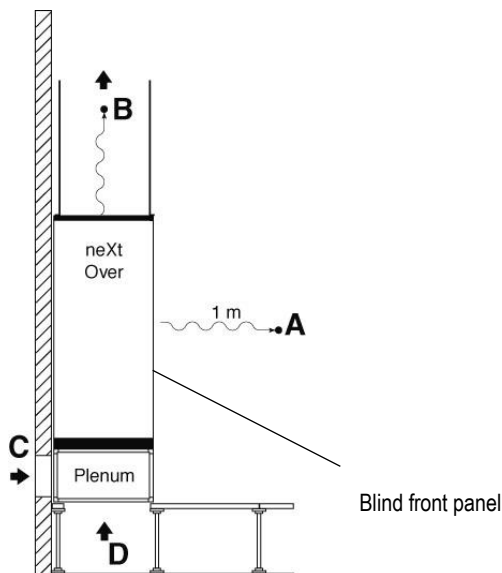

Lp A = Radiated Over catalogue value

Lp B = Air delivery Over catalogue value

Lp C = Lp D = Lp A + 6 dB(A) – plenum noise reduction

The points B, C and D do not influence the point A

IMPORTANT

The declared noise levels are intended in free field conditions.

The noise pressure level of an installed unit is affected by the room acoustic characteristics.

Please consider an average noise increase of +4/+6 dB(A).

VALVE PRESSURE DROP CALCULATION AS FUNCTION OF WATER FLOW RATE

Flow coefficient k_v defines the water flow (between 5°C and 40°C) expressed in m³/h that cross a valve with a pressure drop of 1bar (100kPa).

With this data is possible to calculate the localized pressure drop as function of the water flow rate.

$$\Delta P = (Q / k_v)^2$$

ΔP (bar) = localized pressure drop of valve;

Q (m³/h) = water flow rate – it varies according to the desired operating condition;

k_v (m³/h) = valve flow coefficient.

The formula allows to calculate the value of the localized pressure drop (in bar).

The pressure drops values showed on the documentation are supplied in kPa.

Is possible to change from one unit to another through the following conversion.

$$1 \text{ bar} = 100\text{kPa}$$

CALCULATION EXAMPLE OF 2-WAY VALVE FOR BY-PASS PRESSURE DROP IN FUNCTION OF CHILLED WATER COIL WATER FLOW RATE

w-NEXT S 120 E8 – CHILLED WATER COIL

Example at nominal conditions. Characteristics referred to entering air at 24°C-50%RH with chilled water temperature 7-12°C - 0% glycol.

Water flow rate: 20,9 m³/h

Valve flow coefficient k_v : 25 m³/h

$$\text{2-way valve for by-pass pressure drop: } \Delta P = (Q / k_v)^2 = (20,9 / 25)^2 = 0,698 \text{ (bar)} * 100 \text{ (kPa / bar)} = 69,8 \text{ kPa}$$

**AIR FILTERS REPLACEMENT
FOR UNDER VERSION MACHINES SIZE E3P – E4 – E5 – E6 – E7 – E8 – E9 – E10**

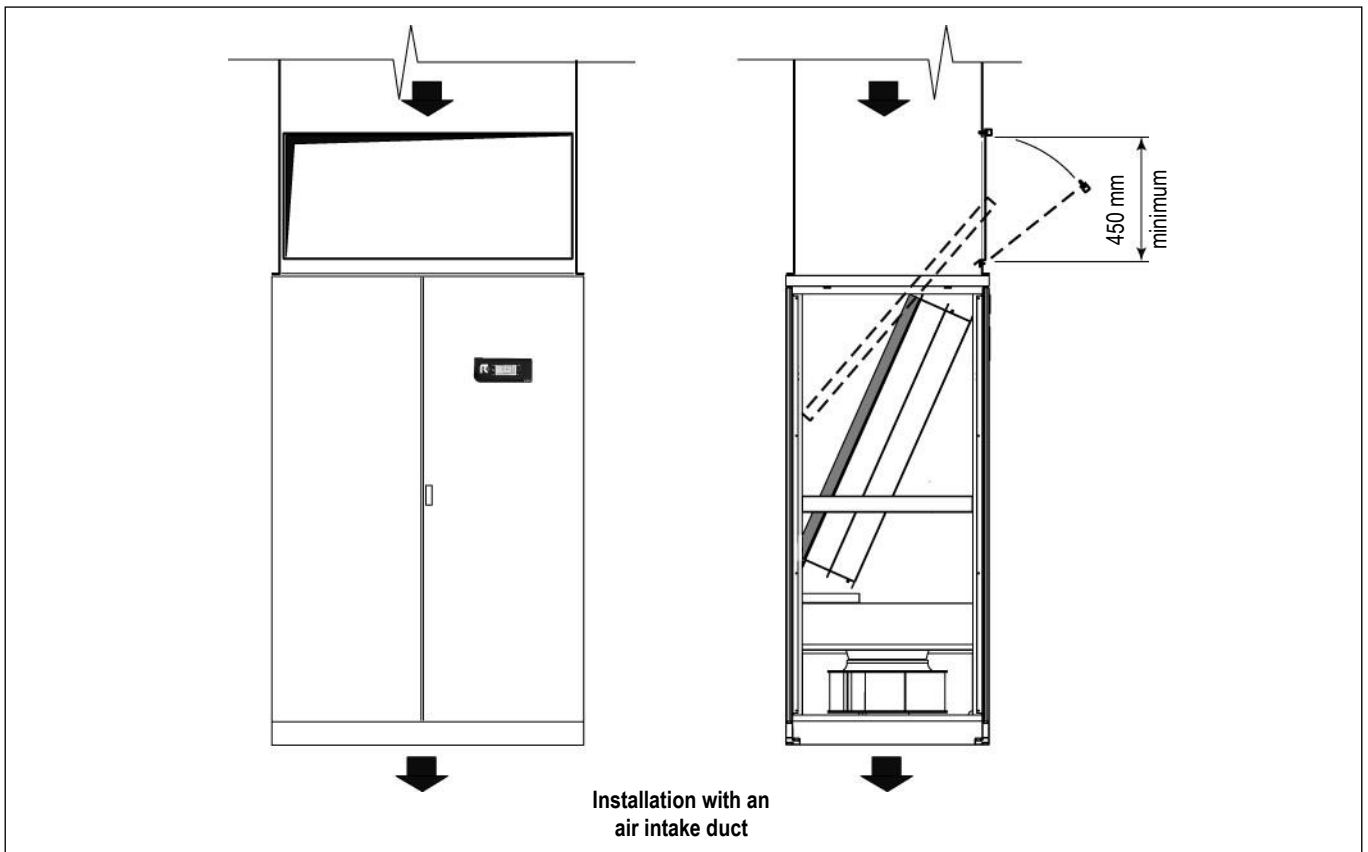
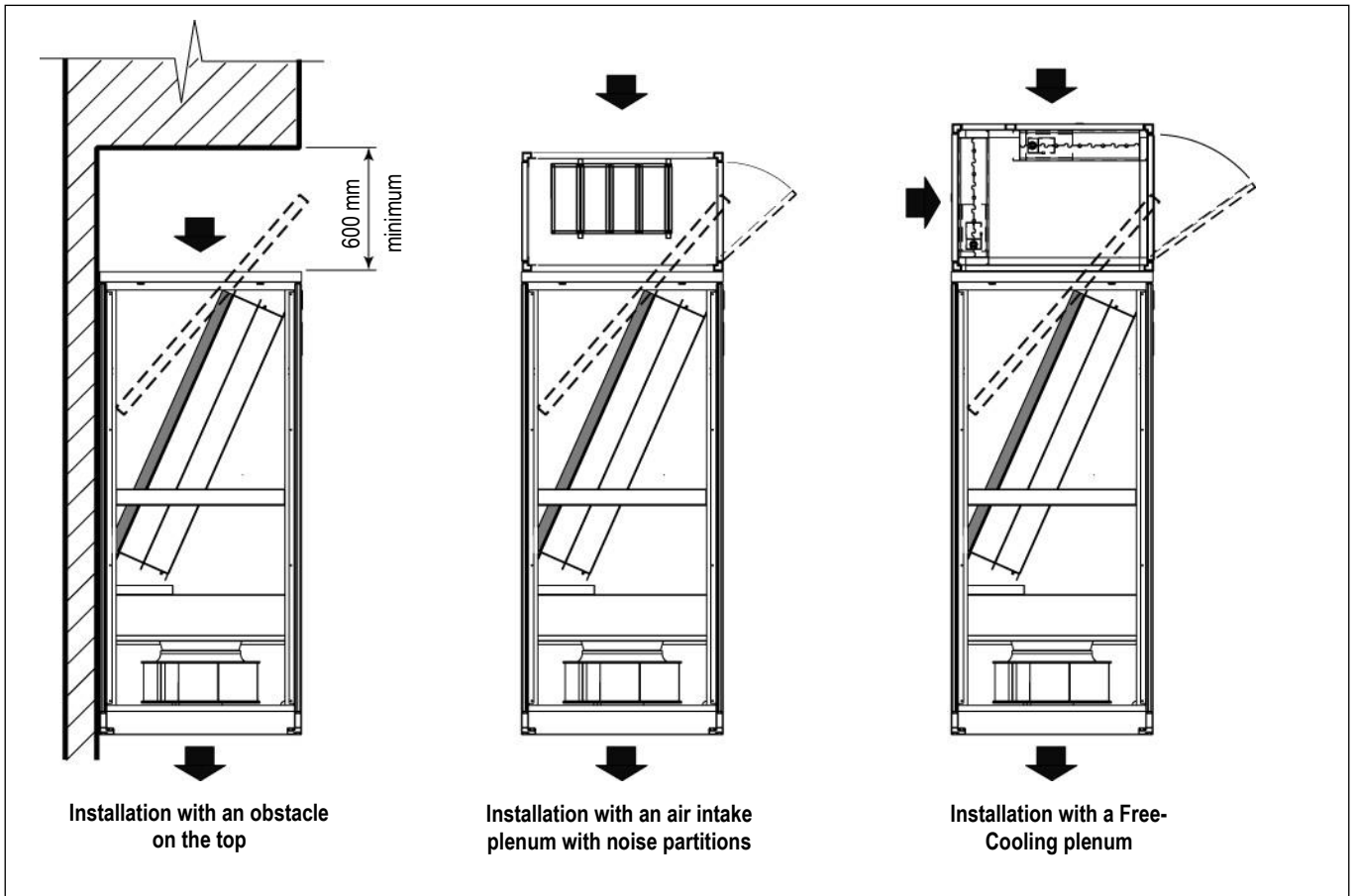



for a greener tomorrow

Eco Changes is the Mitsubishi Electric Group's environmental statement, and expresses the Group's stance on environmental management. Through a wide range of businesses, we are helping contribute to the realization of a sustainable society.



MITSUBISHI ELECTRIC HYDRONICS & IT COOLING SYSTEMS S.p.A.

Via Roma 5 • 27010 Valle Salimbene (PV) • Italy
Ph. +39 0382 433811 • Fax +39 0382 587148

www.rcitcooling.com
www.melcohit.com